



# 1 TONNE ENGINE CRANE - BUYER'S GUIDE

## DON'T GET CAUGHT SHORT

ALL CRANES ARE NOT EQUAL

### CHEAPER MODELS



Light Weight  
72.5kg

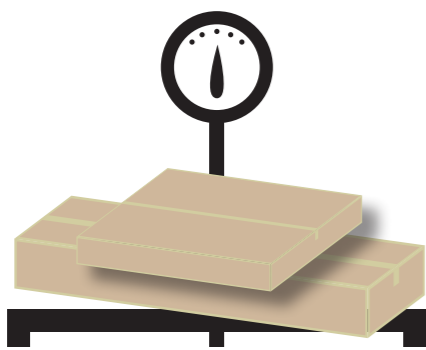

Small Tube Section  
50x70mm x 2.8mm Wall

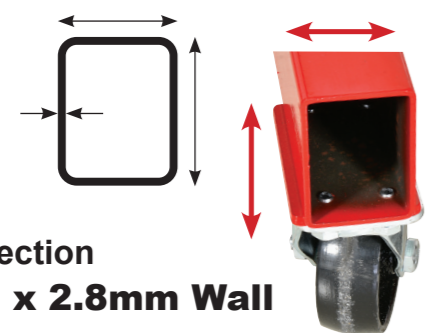

Small Lifting Capacity  
1 Tonne



Smaller Pump Diameter  
Ø70mm  
Slower Pump Action  
Single



### HAFCO

A350



Heavy Weight  
90kg

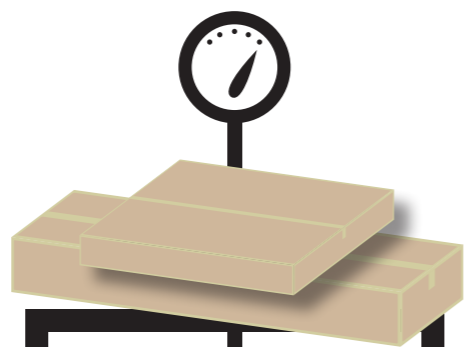

Large Tube Section  
70x70mm x 3.8mm Wall

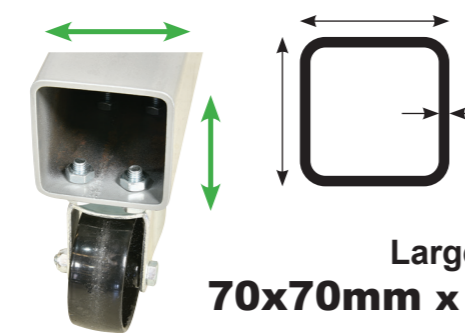

Large Lifting Capacity  
1.25 Tonne



Large Pump Diameter  
Ø75mm  
Faster Pump Action  
Double

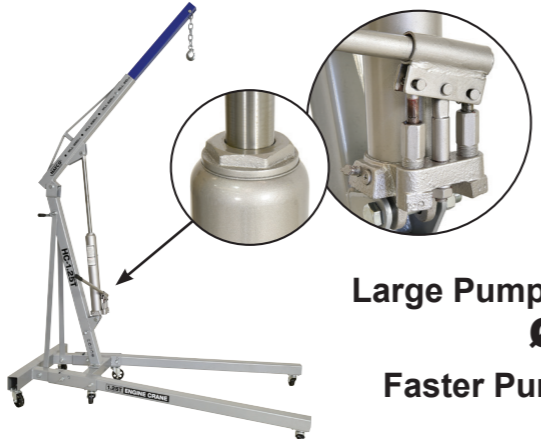

# 1 TONNE ENGINE CRANE - BUYER'S GUIDE

## DON'T GET CAUGHT SHORT

ALL CRANES ARE NOT EQUAL

### CHEAPER MODELS



Less Lifting Height  
1870mm



Less Reach  
960mm



Less Stability  
50mm

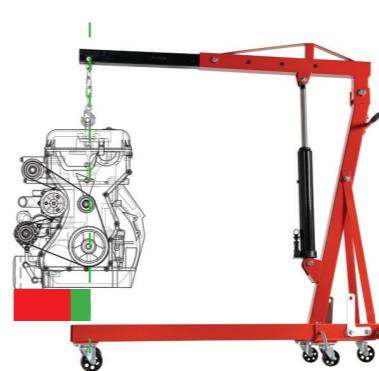

Less Clearance  
710mm



### HAFCO

A350



More Lifting Height  
2300mm



More Reach  
1050mm

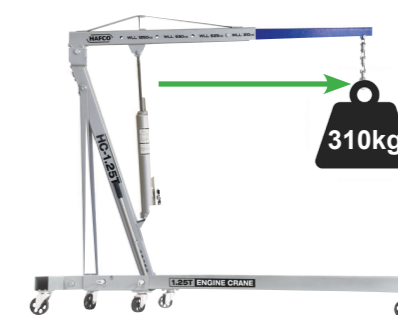

More Stability  
290mm

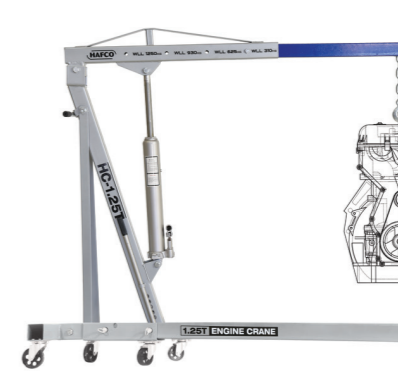

More Clearance  
1100mm



Clearance based on a V8 Engine @ 610kg Jib Setting