

PP-13C
Drill Sharpener

INSTRUCTION MANUAL
Order Code: D111



Safety Instructions

**RESPONSIBILITIES
SUPERVISOR OR OWNER**

- ⊙ Ensure equipment is maintained in accordance with the manufacturer’s specifications.
- ⊙ Ensure compliance with Health and Safety requirements.
- ⊙ Ensure competency of operator.

OPERATOR

- ⊙ Comply with Safety instructions of this operators manual.
- ⊙ Report & tag the machine. Do not operate if the equipment is faulty.

	SAFETY EYEWEAR	Safety glasses must be worn at all times in work areas
	SAFETY FOOTWEAR	Safety footwear must be worn when operating this equipment
	SAFETY EARWEAR	Safety earwear must be worn when operating this equipment

KNOWN HAZARDS

- Entanglement
- Cuts/abrasions
- Eye injuries
- Inhalation of grinding dust
- Hot objects
- Noise

PRE-START

1. Complete pre-start check of equipment including checking electrical cord and grinder wheel for damage.
2. Ensure all guarding and attachments are secure and fitted correctly.
3. Identify ON/OFF and Emergency stop buttons.
4. Keep bystanders clear and warn others of your intention to use the equipment.
5. Check the electrical lead for a current compliance tag.
6. Ensure no slip/trip hazards are present in the workspace and work surface.
7. Keep this manual available to operators to ensure the safe use of this equipment.

OPERATION

1. Wear the appropriate PPE equipment.
2. Use equipment only for its intended purpose.
3. Keep loose hair and clothing clear of any moving parts.
4. Follow the correct procedure as per manual for sharpening the different size drill bits.
5. Ensure work area is dry and uncluttered.

END OPERATIONS & CLEANING UP

1. Turn off the machine.
2. Remove sharpened drill bit.
3. Clean up the work area and the machine.
4. Immediately report suspect equipment and place an “Out Of Service” tag on the front of the machine.



WARNING.

When operating a grinder it is important to wear appropriate safety gear to protect yourself from injury. This includes safety glasses or goggles, or a face shield to protect your eyes from flying debris.

Application

1. Grinding is accurate and rapid, an easy operation with little skill required.
2. Economically priced which greatly reduces the cost and improves effectiveness.
3. Fitted with a diamond grinding wheel, it can produce a precision angle and has a long service life.
4. The powerful electronically controlled DC motor has stable frequency, strong horsepower and provides long service life.
5. The machine is set up with the function to relieve the lip angle (central point). This relief area prevents contact with the metal being cut as a hole is drilled. This reduces drag and friction.

Specifications

Order Code..... D111
 Model No..... PP-13C
 Grinding Range 3 ~ 13mm
 Power 240V 50HZ
 Motor Watts..... 120
 Motor Speed 1400rpm
 Dimensions..... 32 x 18 x 19cm
 Weight 9kg

Standard Equipment
 11 x ER20 Collets 3~13mm
 1 x Collet Chuck
 1 x Power Lead
 1 x CBN Coated Grinding Wheel

Identification

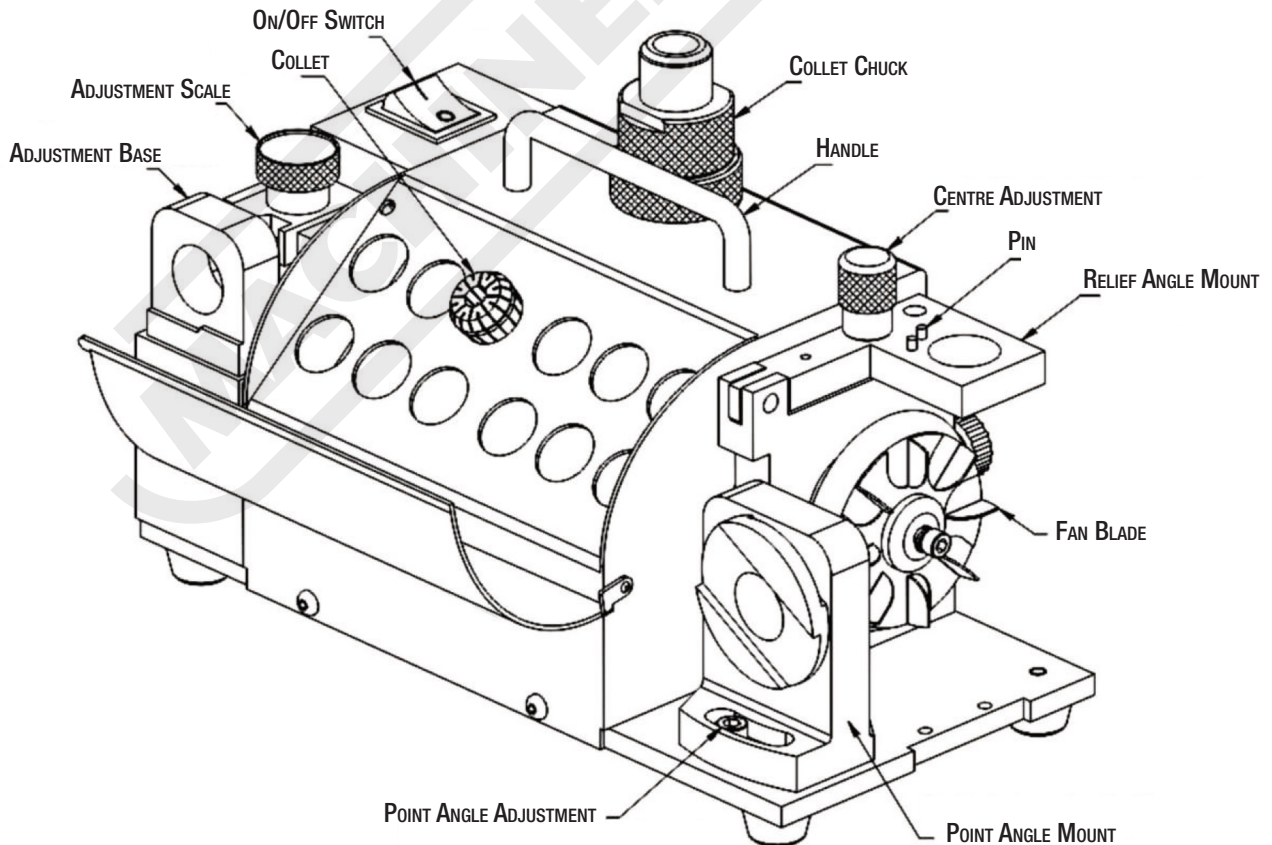

Operation

A. Setup The Drill In The Collet Chuck

Please follow steps 1,2 to set up the drill bit to the chuck (without tightening)

1. Determine diameter of your drill bit, and then select the appropriate size collet.
2. At a 45°angle, insert the collet into the collet chuck and tighten the nut slightly.
3. Insert the drill bit into the collet chuck and with the point protruding 35mm or so from the collet chuck, but do not tighten the drill too tight.

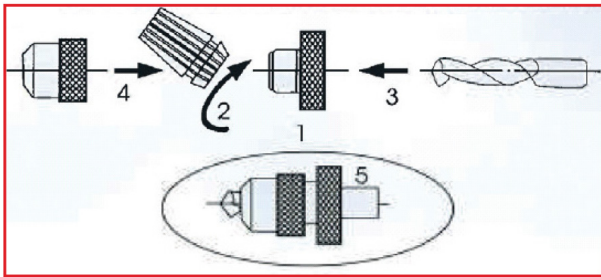

Setup the Drill in the Collet ready for Sharpening

First rotate the dial **A** fully clockwise until it can no longer rotate. Wind the dial anti-clockwise to dial up the size of the drill to be ground and then place the drill chuck **B** in the opening in front of the dial. Slide the drill into the chuck from the rear and twist the drill clock-wise until it stops.

Now twist the drill chuck clock-wise until it stops and then tighten the drill chuck using the outer knurled section.

The drill is set now ready to grind.

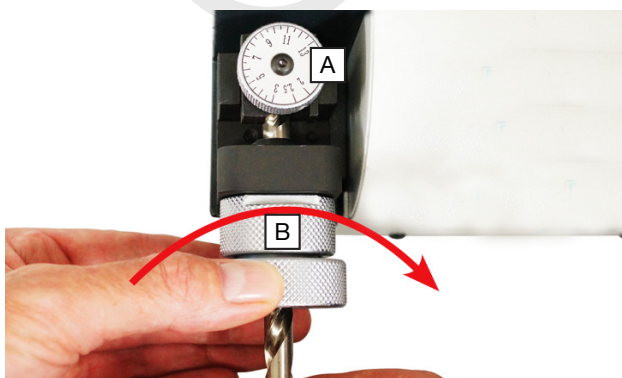

Grinding the Leading Edge

Turn on the drill sharpener and then place the drill chuck in the sharpening fixture in the base of the machine and ensure that the chuck is in the location slot. Move the chuck in slowly until the grinding takes place and rotate the chuck in a clockwise and anti clockwise direction until the drill chuck is completely home and the grinding stops. Take out the chuck and rotate the chuck 180° then repeat the operation.



Grinding Heel Clearance

Once the drill has been ground then place the chuck in the top fixture and locate the slot. Rotate back and forth until all grinding stops. Take out the chuck and rotate 180° and repeat the operation.

The amount of grinding in this operation determines the amount of split point and heel relief.

It is advisable to remove the chuck often and view the results.



WARNING

General Machinery Safety Instructions

Machinery House
requires you to read this entire Manual before using this machine.

- 1. Read the entire Manual before starting machinery.** Machinery may cause serious injury if not correctly used.
- 2. Always use correct hearing protection when operating machinery.** Machinery noise may cause permanent hearing damage.
- 3. Machinery must never be used when tired, or under the influence of drugs or alcohol.** When running machinery you must be alert at all times.
- 4. Wear correct Clothing.** At all times remove all loose clothing, necklaces, rings, jewelry, etc. Long hair must be contained in a hair net. Non-slip protective footwear must be worn.
- 5. Always wear correct respirators around fumes or dust when operating machinery.** Machinery fumes & dust can cause serious respiratory illness. Dust extractors must be used where applicable.
- 6. Always wear correct safety glasses.** When machining you must use the correct eye protection to prevent injuring your eyes.
- 7. Keep work clean and make sure you have good lighting.** Cluttered and dark shadows may cause accidents.
- 8. Personnel must be properly trained or well supervised when operating machinery.** Make sure you have clear and safe understanding of the machine you are operating.
- 9. Keep children and visitors away.** Make sure children and visitors are at a safe distance for you work area.
- 10. Keep your workshop childproof.** Use padlocks, Turn off master power switches and remove start switch keys.
- 11. Never leave machine unattended.** Turn power off and wait till machine has come to a complete stop before leaving the machine unattended.
- 12. Make a safe working environment.** Do not use machine in a damp, wet area, or where flammable or noxious fumes may exist.
- 13. Disconnect main power before service machine.** Make sure power switch is in the off position before re-connecting.
- 14. Use correct amperage extension cords.** Undersized extension cords overheat and lose power. Replace extension cords if they become damaged.
- 15. Keep machine well maintained.** Keep blades sharp and clean for best and safest performance. Follow instructions when lubricating and changing accessories.
- 16. Keep machine well guarded.** Make sure guards on machine are in place and are all working correctly.
- 17. Do not overreach.** Keep proper footing and balance at all times.
- 18. Secure workpiece.** Use clamps or a vice to hold the workpiece where practical. Keeping the workpiece secure will free up your hand to operate the machine and will protect hand from injury.
- 19. Check machine over before operating.** Check machine for damaged parts, loose bolts, Keys and wrenches left on machine and any other conditions that may effect the machines operation. Repair and replace damaged parts.
- 20. Use recommended accessories.** Refer to instruction manual or ask correct service officer when using accessories. The use of improper accessories may cause the risk of injury.
- 21. Do not force machinery.** Work at the speed and capacity at which the machine or accessory was designed.
- 22. Use correct lifting practice.** Always use the correct lifting methods when using machinery. Incorrect lifting methods can cause serious injury.
- 23. Lock mobile bases.** Make sure any mobile bases are locked before using machine.
- 24. Allergic reactions.** Certain metal shavings and cutting fluids may cause an allergic reaction in people and animals, especially when cutting as the fumes can be inhaled. Make sure you know what type of metal and cutting fluid you will be exposed to and how to avoid contamination.
- 25. Call for help.** If at any time you experience difficulties, stop the machine and call you nearest branch service department for help.

WARNING

Drill Sharpener Safety Instructions

Machinery House
requires you to read this entire Manual before using this machine.

- 1. Maintenance.** Make sure the Drill Sharpener is turned off and disconnect from the main power supply and make sure all moving parts have come to a complete stop before any inspection, adjustment or maintenance is carried out.
- 2. Drill Sharpener Wheel Condition.** Drill Sharpener must be maintained for a proper working condition. Never operate a Drill Sharpener with a damaged or badly worn wheel. Replace if required. Scheduled routine maintenance should be performed on a scheduled basis.
- 3. Secure your Drill Sharpener.** Make sure you firmly secure your Drill Sharpener to a stand or workbench. An unsecured Drill Sharpener can become dangerously out of control during operation.
- 4. Hand Hazard.** Keep a firm grip of material and position your hands a safe distance away when grinding. Serious injury can occur if hand or finger tips come in contact with grinding wheels, abrasives or moving parts.
- 5. Leaving a Drill Sharpener Unattended.** Always turn the Drill Sharpener off and make sure all moving parts have come to a complete stop before leaving the Drill Sharpener. Do not leave Drill Sharpener running unattended for any reason.
- 6. Avoiding Entanglement.** Drill Sharpener guards must be used at all times. Remove loose clothing, belts, or jewelry items. Tie up long hair and use the correct hair nets to avoid any entanglement with the Drill Sharpener moving parts.
- 7. Understand the machine's controls.** Make sure you understand the use and operation of all controls.
- 8. Power outage.** In the event of a power failure during use of the machine, turn off all switches to avoid possible sudden start up once power is restored.
- 9. Work area hazards.** Keep the area around the Drill Sharpener clean from oil, tools, chips. Pay attention to other persons in the area and know what is going on around the area to ensure unintended accidents.
- 10. Starting Drill Sharpener.** If a wheel is damaged it may fly apart shortly after start up. To avoid any injury, always stand to the side of the Drill Sharpener when turning it on, allow it to gain full speed and wait for 1 minute before standing in front of Drill Sharpener.
- 11. Workpiece Handling.** Never hold small workpieces with your fingers during sharpening. Always support the workpiece, with correct collets etc. Never use excessive force when drill sharpening or serious injury can occur.
- 12. Hearing protection and hazards.** Always wear hearing protection as noise generated from Drill Sharpener and workpiece vibration can cause permanent hearing loss over time.
- 13. Eye protection.** Always wear safety glasses when using this machine. Small particles become airborne at high speed and can cause serious eye injury. Use Grinding shields on machine at all times.
- 14. Use correct size collets for the job.** Always use the correct size collets when drill sharpening.
- 15. Starting position/speed.** Never turn the Drill Sharpener on when the workpiece is resting on the grinding wheel. Allow wheel to reach full speed before grinding.
- 16. Guards.** Do not operate Drill Sharpener without the correct guards in place.
- 17. Stopping the grinding wheel.** Do not stop or slow the wheel with your hand or workpiece. Allow the machine to stop on its own.
- 18. Dust hazard.** Grinding causes hazardous dust, which may cause long term respiratory problems if inhaled. Always wear an approved respirator when grinding.
- 19. Call for help.** If at any time you experience difficulties, stop the machine and call your nearest branch service department for help.

PLANT SAFETY PROGRAM

NEW MACHINERY HAZARD IDENTIFICATION, ASSESSMENT & CONTROL

Drill Sharpener

Developed in Co-operation Between A.W.I.S.A and Australia Chamber of Manufactures
 This program is based upon the Safe Work Australia, Code of Practice - Managing Risks of Plant in the Workplace (WHSA 2011 No10)

Item No.	Hazard Identification	Hazard Assessment	Risk Control Strategies <small>(Recommended for Purchase / Buyer / User)</small>
A	ENTANGLEMENT	HIGH	Eliminate. avoid loose clothing / Long hair etc.
B	CRUSHING	LOW	Secure & support work material when grinding.
C	CUTTING, STABBING, PUNCTURING	MEDIUM	Isolate power to machine prior to any checks or maintenance being carried out. Do not adjust or clean machine until the machine has fully stopped.
D	SHEARING	MEDIUM	Make sure all guards are secured shut when machine is on. Isolate power to machine prior to any checks or maintenance.
E	FRICITION	MEDIUM	Keep hands and body away from grinding wheel.
F	STRIKING	MEDIUM	Ensure grinding wheels are tightly secured on spindle. Wear safety glasses. Stand clear of moving parts on machine. Check grinding wheels for damage before use. Remove all loose objects around moving parts. Ensure jobs are locked tight when grinding.
H	ELECTRICAL	MEDIUM	All electrical enclosures should only be opened with a tool that is not to be kept with the machine.
M	HIGH TEMPERATURE	LOW	Machine should be installed & checked by a Licensed Electrician.
O	OTHER HAZARDS, NOISE.	LOW	Wear appropriate protective clothing to prevent hot sparks. Wear hearing protection as required.
Plant Safety Program to be read in conjunction with manufactures instructions			



www.machineryhouse.com.au

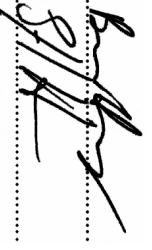

www.machineryhouse.co.nz

Authorised and signed by:
 Safety officer:
 Manager: 

Revised Date: 12th March 2012



ENVIRONMENT PROTECTION

Recycle unwanted materials instead of disposing of them as waste. All tools, accessories and packaging should be sorted, taken to a recycling centre and disposed of in a manner which is compatible with the environment. When the product becomes completely unserviceable and requires disposal, drain any fluids (if applicable) into approved containers and dispose of the product and fluids according to local regulations.

Imported by

HARE & FORBES
MACHINERYHOUSE

Australian Distributor

Hare & Forbes
Machineryhouse
Sydney - Melbourne
Adelaide - Brisbane - Perth

Ph: 1300 202 200
www.machineryhouse.com.au

MACHINERYHOUSE

New Zealand Distributor

Machineryhouse
Auckland
Christchurch

Ph: 0800 142 326
www.machineryhouse.co.nz