

# INSTRUCTION MANUAL

**GS11**  
**Easson DRO Scales**  
**800mm**  
**1 $\mu$ m**



**D767**

# Easson

Always Committed to Quality Technology & Innovation

## Installation Instructions

### A. Precaution:

1. The travel length of the glass grating scale must be longer than the maximum travel of the machine, there should be at least 10mm clearance between the ends of the glass scale and the maximum travel of the machine as per the following figure shown.

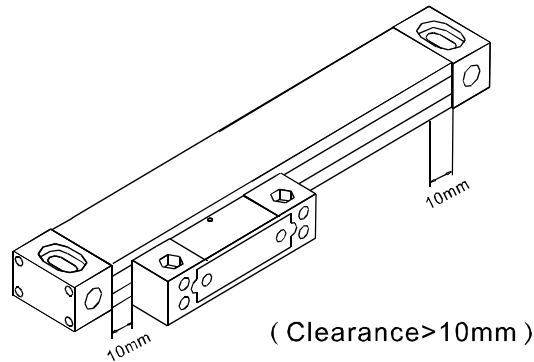

2. To ensure the graduated glass scale to be installed is reliable, and to avoid any possibility of scale misalignment, the scale should be installed on machined flat surfaces of the machine wherever possible. In the case where there are no machined flat surfaces available on the machine, machined flat Blocks or the stainless steel fillers should be used. Wherever possible the scale ends and the reader head should be installed on a flat surface.

3. If a lever dial indicator is used to align the scale, it is important to ensure that the angle between the dial Indicator lever tip and the surface measured must be less than 30° to avoid a cosine measurement Error. If a vertical dial indicator is used as per the following figures shown, it is important to ensure that the dial indicator is perpendicular to the measured surface to also avoid the cosine measurement error.

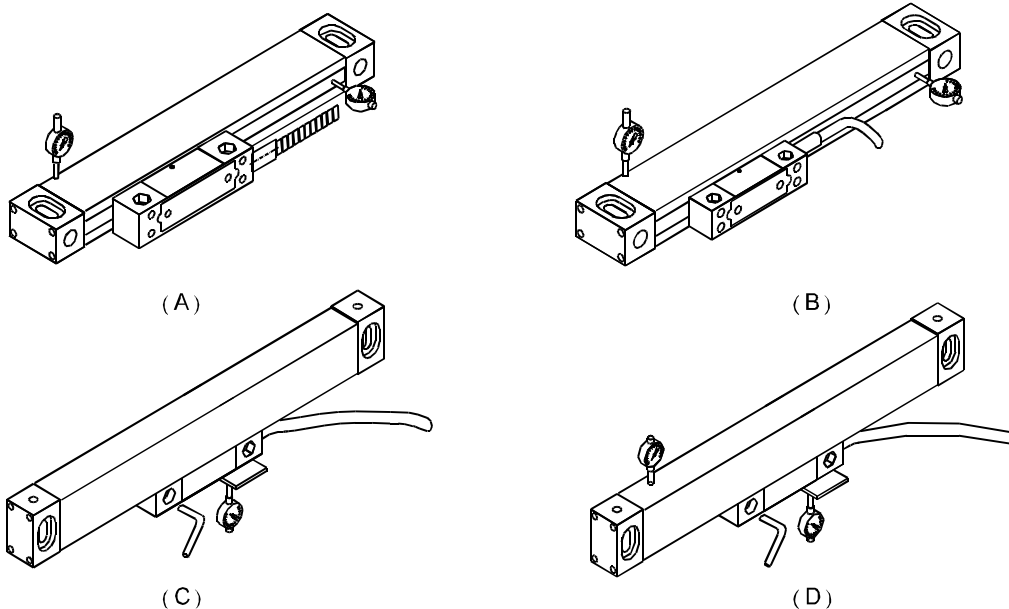

# Easson

Always Committed to Quality Technology & Innovation

## 4. The following considerations must be taken to select the proper installation locations

(1) Scales should be installed on to a machined surface.

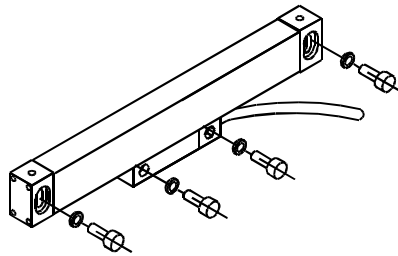

(2) The opening of the scale must not be installed as to be directly exposed to swarf, oil, Water, dust or other foreign products. Covers provided should be installed.

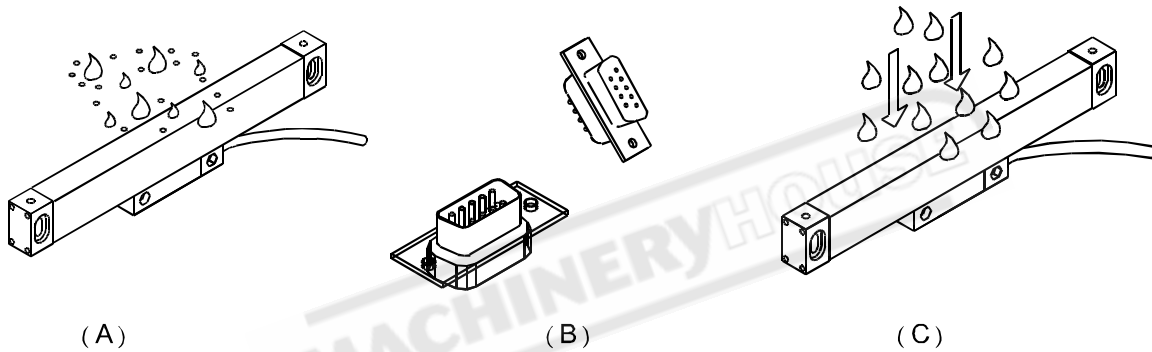

(3) In cases where machined flat surfaces are not available, an installation block or strip should be used to provide a flat datum for the installation. The installation strip must be as short as possible to provide a rigid datum.

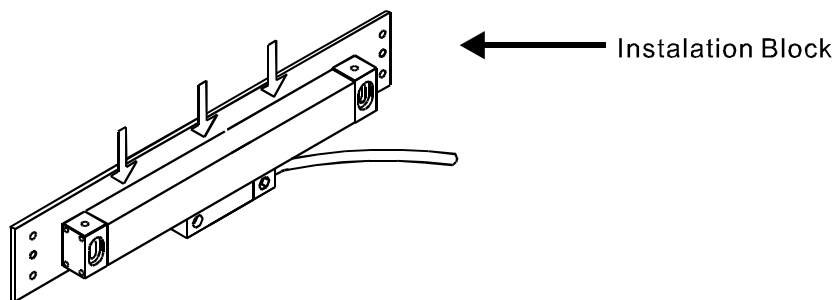

(4) A clearance of at least 3.0mm between the scale and scale cover.

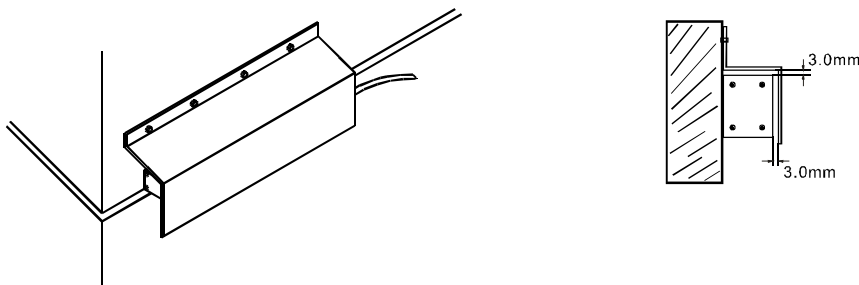

# Easson

Always Committed to Quality Technology & Innovation

5. All the tapped screw holes must have at least 6 threads to allow the screw to be firmly secured into the tapped holes. For the screw that is needed to secure a heavy load, the tapped holes must have at least 8 threads. After tapping the holes must be deburred and cleaned.

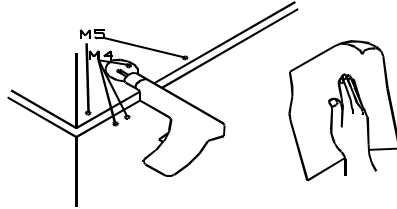

6. All cables must be fixed, but allow for the maximum machine travel movements. Below are diagrams, recommending the minimum radius that should be used for bending the scale cable.

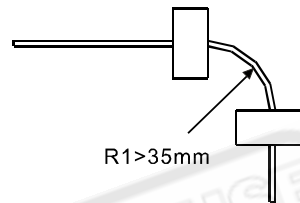
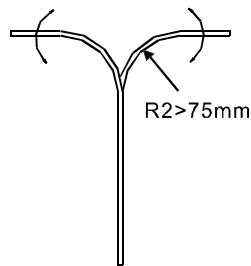

7. Grounding / Earthing is very important for the noise immunity, the grounding resistance must be less than 1.0 ohm.

8. The horizontal and Vertical alignment measurement are taken at 20mm away from the scale ends as per following figure shown.

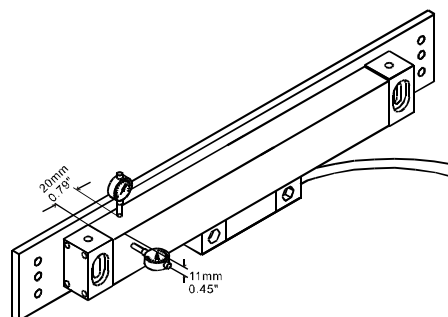

# Easson

Always Committed to Quality Technology & Innovation

## B. Installation standards & Requirements

### 1. Requirements for the mounting surface

- a) if the scale mounting surfaces are not parallel to each other (i.e. As per shown in figure A and B), the parallelism of the two mounting surfaces must be less than 0.1mm.
- b) If the mounting surfaces are perpendicular to each other. (I.e.As per shown in figure c), the squareness of these two mounting surfaces must be less than 0.1mm.

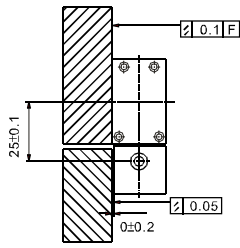

(A)

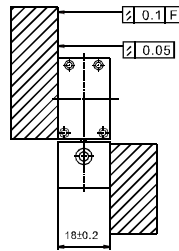

(B)

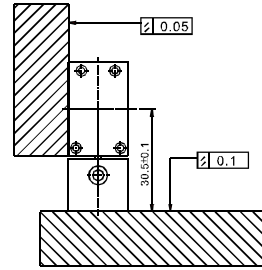

(C)

### 2. Scale Alignment

it is very important that the scale must be aligned parallel to the travel of the machine slide.

For scale travel less than 950mm, the maximum parallel error between the scale and the machine slide must be less than 0.1mm 0.15mm.

For scale travel longer than 950mm, the maximum alignment parallelism error must be less that 0.1mm.

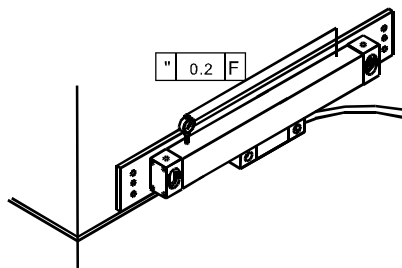

L > 950mm

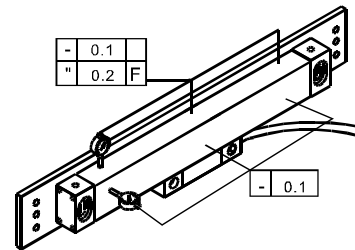

L ≤ 950mm

# Easson

Always Committed to Quality Technology & Innovation

### 3. Clearnces between the reader head and scale body:

- (1) The clearance between the reader head and scale body must be kept between 0.8mm-1.5mm.
- (2) The reader head must be less than 0.5mm parallel with the scale and can be set with feeler gauges to allow the reader head to move unrestricted along the scale.

### Milling Machine Table Direction

The diagram below shows reading against table travel

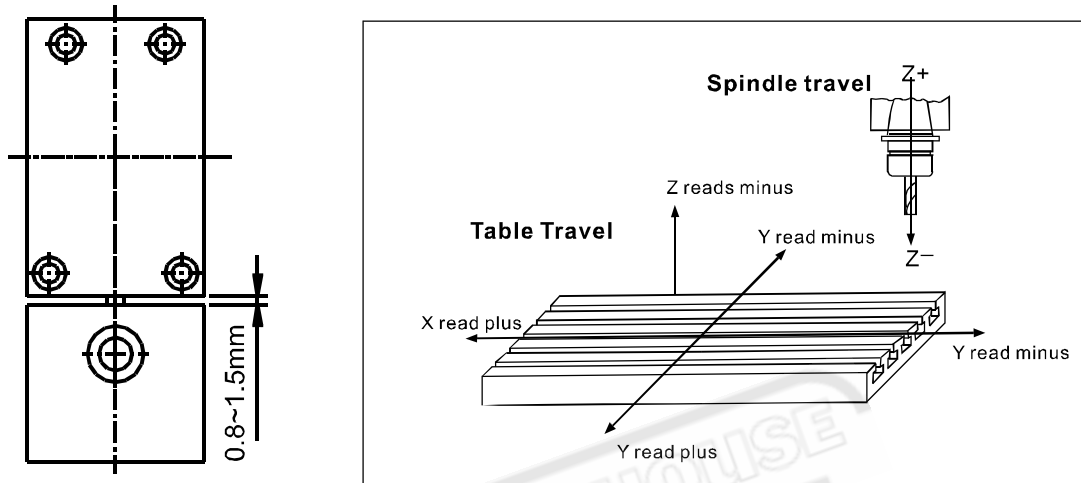

### Direction on Lathe Installation

when travelling towards the headstock the reading should be reducing. Cross slide towards the centre should be reducing.

### Note!

At all times to give the best protection the scale should be mounted with the rubber seals facing down.

Where extreme exposure to swarf, coolant, dirt and compressed air, are present, sheet metal cover guards that are supplied should be placed over the scale for maximum protection. Between the scale and the reader head there is a blue strip which helps to maintain the correct distance between the reader head and the scale. This should be removed after installation

### Scale Reading Direction

Before fitting the scale insure that the reading direction is correct. To change the direction of the reading of the scale, turn the scale over. Generally the scale is reading in the correct direction with the label of the scale exposed.

### Lathe Scale Installation

Before fitting the scale connect the "x" axis to the cross slide to allow the Diameter function to work.

# Easson

Always Committed to Quality Technology & Innovation

## Fixing the "X" Scale on a Milling Machine

One of the easiest ways to set up an X scale on a milling machine, if the side of the table is machined, is to clamp two parallels to the flat table surface that the table travels on and sit the Scale on the parallels.

Carefully drill and tap the holes to take the screws provided

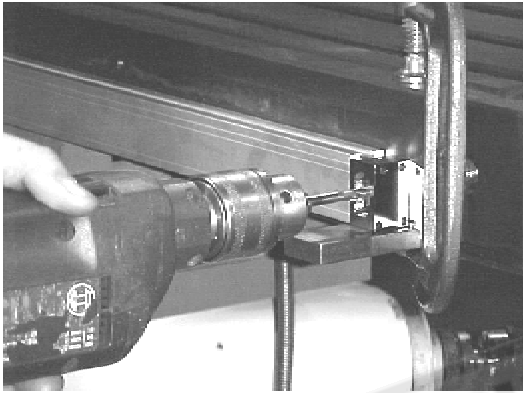

Mount the cover over the scale and drill and tap the holes to secure it to the table making sure that there is 3mm clearance between the cover and the scale.

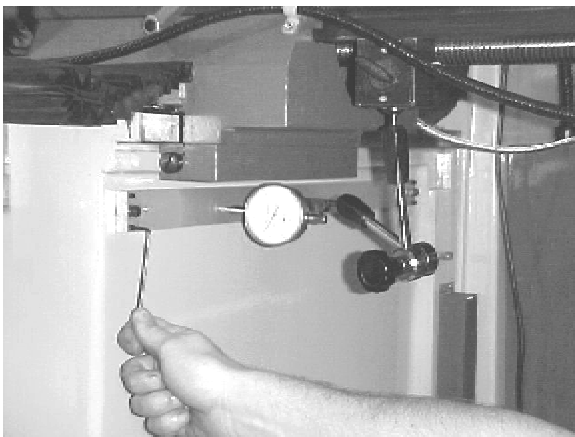

Mount the scale on the backing plate using the pre drilled holes, checking that the scale is parallel with the machine slide with a dial indicator



When the scale is mounted then fix the reader head to the saddle, if necessary packing the head to insure that it is Parallel and in line with the scales. (The blue packing between the reader head and scale allows for the correct clearance and holds the reader head parallel to the scale.)



### Attaching the "Y" Axis Scale.

If the surface is not machined mount the backing plate and use the grub screws to adjust the backing plate, checking with a dial indicator, until the scale is square and perpendicular to the machine slides.

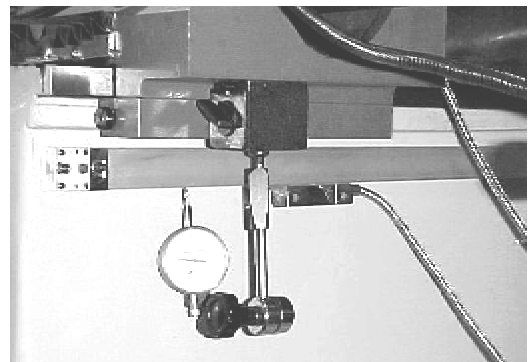

# Easson

Always Committed to Quality Technology & Innovation



Mount the bracket on the scaddle to take the reader head making sure that the reader head is in line and parallel to the Scale. Secure the cable making sure to leave enough free cable to allow for the travel of the slide.

## Fitting the "Z" Axis

Before mounting the scale insure that it will read "+" as you wind the table down, increasing the distance from the table to the cutter

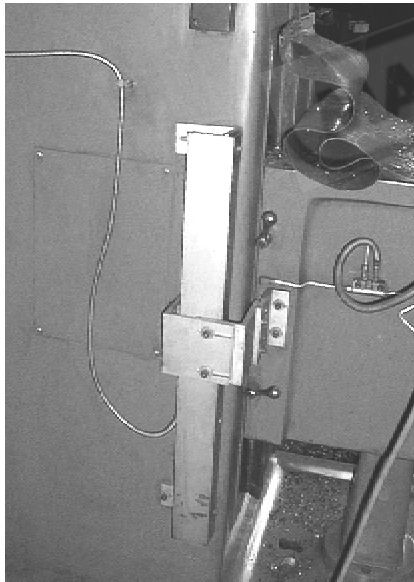
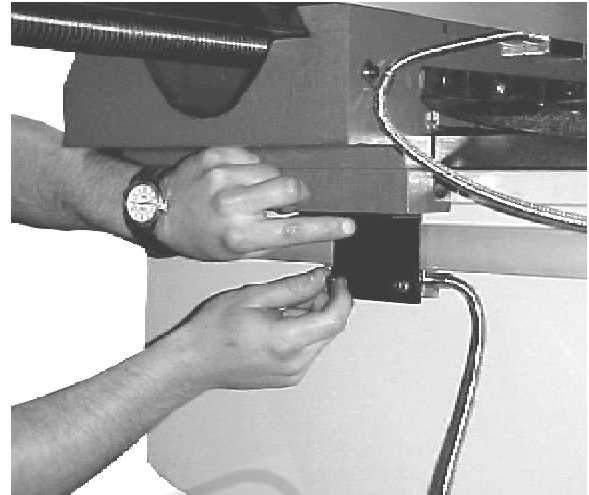

**Fig.1**

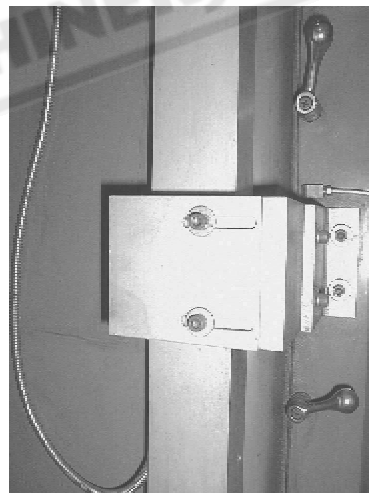

**Fig.2**



**Fig.3**

The "z" axis scale should be installed on the side of the column insuring that the open side of the scale is away from direct swarf and coolant and that the travel is in the right direction "-" towards the spindle and "+" away from the spindle. (Fig.1) The bracket is (Fig 2) mounted of the knee, and around the scale to allow for the cover (Fig .3) to protect the scale where excessive coolant & swarf are present.



# Easson

Always Committed to Quality Technology & Innovation

## LATHE INSTALATION

To install a readout on a lathe the following tips can be used. To mount the cross slide scale select a flat surface that is suitable and clear of the travelling parts of the lathe.

The scale should be mounted insuring that that it is parallel and square to the slide.

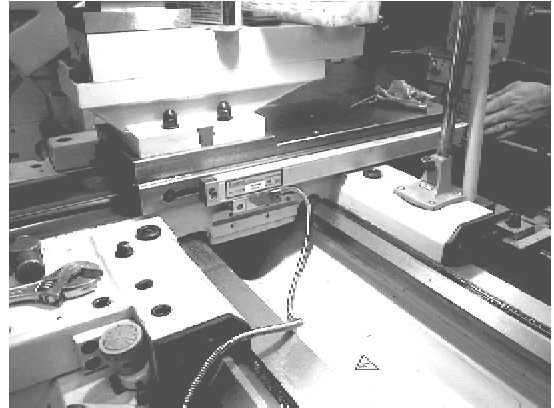

Testing for parallel can be done by either a dial indicator or a precision level

When mounting the reader head if necessary pack the reader head so that it travels in line and square to the scale to avoid any damage to the scale.

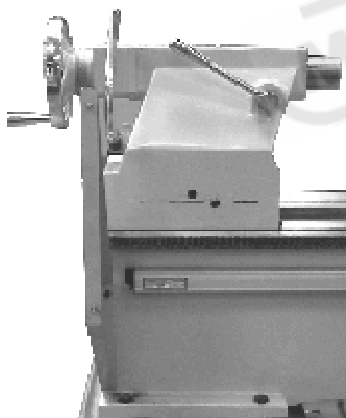

Fig .1

The longitudinal scale should be mounted on the back of the lathe (Fig 1)with the open side of the scale facing down and must be parallel to the bed. The reader head is mounted to the saddle (Fig .2 & 3)via the brackets provided. Some modification may be required for some lathes. Covers should be mounted over the slides as per Fig 4

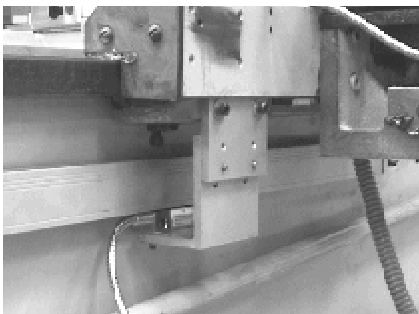

Fig .2

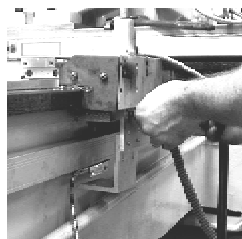

Fig .3

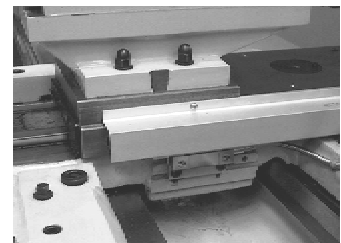
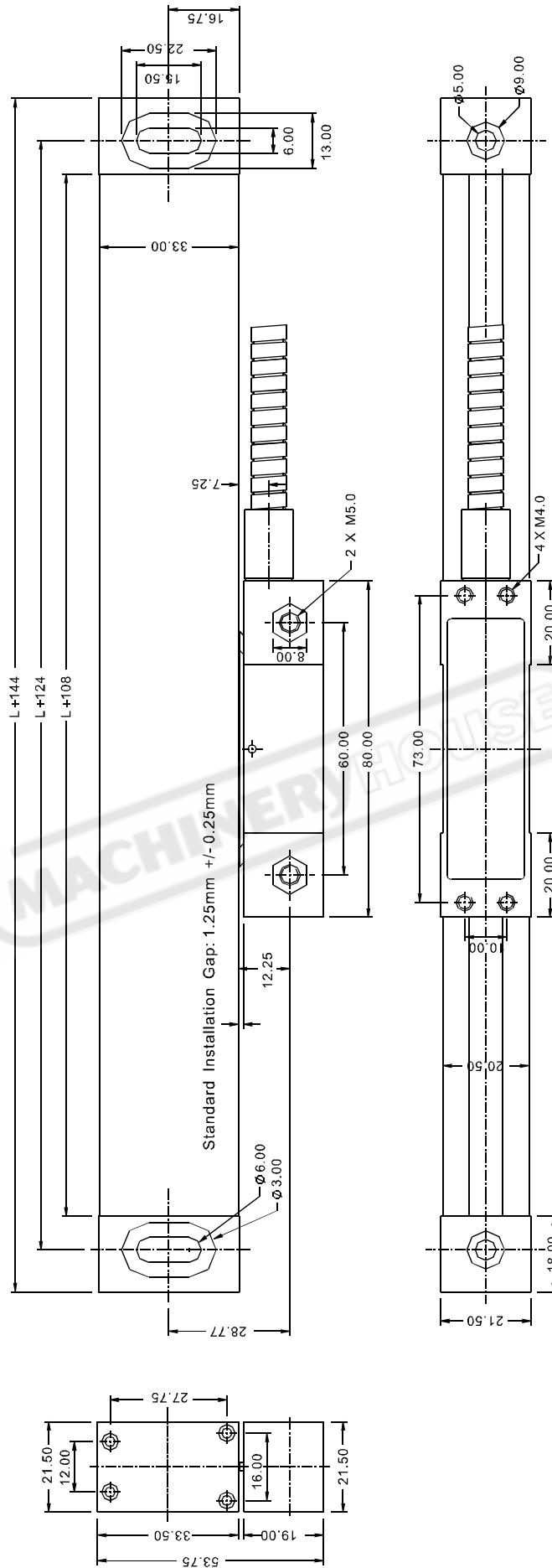

Fig .4



Gs11 Series Glass Grating Linear Transducer Installation Dimensions