



EDITION : 1.0
DATE: (11/24)

Instruction Manual

MAGNETIC BASE DRILL HF-750

ORDER CODE: (D9507)

MACHINE DETAILS

MACHINE.	MAGNETIC BASE DRILL
MODEL NO.	HF-750
SERIAL NO.	
DATE OF MANF.	

IMPORTED BY

AUSTRALIA



www.machineryhouse.com.au

NEW ZEALAND



www.machineryhouse.co.nz

NOTE:

This manual is only for your reference. At the time of the compiling of this manual every effort to be exact with the instructions, specifications, drawings, and photographs of the machine was taken. Owing to the continuous improvement of the HAFCO METALMASTER machine, changes may be made at any time without obligation or notice. Please ensure the local voltage is the same as listed on the specification plate before operating any electric machine.

SAFETY SYMBOLS:

The purpose of safety symbols is to attract your attention to possible hazardous conditions



WARNING

CAUTION

Note:

Indicates a potentially hazardous situation causing injury or death

Indicates an alert against unsafe practices.

Used to alert the user to useful information

NOTE:

In order to see the type and model of the machine, please see the specification plate. Usually found on the back of the machine. See example (Fig.1)

	
PRODUCT SPECIFICATIONS	
Model: HF-750	Voltage: 240V, 50Hz
Capacity: 75mm	Motor: 2 KW
Nett Weight: 24.8 kg	FLC: 8.7 Amps
Date:	
Serial No:	
www.machineryhouse.com.au	www.machineryhouse.co.nz
Made in Taiwan	

Fig.1

CONTENTS:

GENERAL MACHINE INFORMATION	
Specifications.....	4
Included Accessories.....	4
Identification.....	5
IMPORTANT INFORMATION	
General Powertool Safety.....	6
Terminology Used In The Manual.....	7
Drill Safety Warnings.....	8
Magnetic Drill Specific Safety.....	9
Magnetic Base Duty Cycle.....	9
SETUP	
Assembly.....	10
Mounting The Annular Cutters.....	10
OPERATION	
Operation General.....	10
Changing Tools & Adaptors With 3MT Shank.....	11
MT3 Annular Cutter Adaptor.....	11
Speed Selection.....	12
Avoid Overheating The Motor.....	13
Cutting Speeds.....	13
Recommended Surface Speed.....	13
Reversing Switch.....	13
Twist Drilling.....	14
Arbor Support Bracket Replacement.....	14
Drill Chuck.....	14
Tapping Operation.....	14
MAINTENANCE	
The Arbor Shaft.....	15
Gib Adjustment (Dovetail Slides).....	15
Carbon Brushes.....	15
Magnetic Troubleshooting.....	16
Checking The Magnet.....	16
Checking The Rectifier.....	16
Spare Parts.....	17
Risk Assessment Sheets.....	22



CAUTION

A prepared list of safety guidelines can never be complete. Every workshop environment is different. Always consider Safety first, as it applies to your individual working conditions. Use this machine and other machinery with caution and respect. Failure to do so could result in serious Personal injury, damage to the equipment, or poor work results.

SPECIFICATIONS

Order Code	D9507
Model	HF-750
Feed	Manual
Drilling Capacity Range - Manual (mm)	12 ~ 75
Maximum Thickness (mm)	50
Suits Cutter Shank Size (mm)	19
Spindle Stroke (mm)	145
Number of Drilling Speeds	4
Full Load Drilling Speeds (rpm)	90 / 120 / 180 / 230
No Load Drilling Speeds (rpm)	150 / 200 / 300 / 380
Magnetic Holding Power (Kg/f)	3263
Motor Power (kW / hp)	1.8 / 2.4
Voltage / Amperage (V / amp)	240 / 10
Machine Weight Only (kg)	24.8
Nett Weight (kg)	31
Hard Case	Yes

INCLUDED ACCESSORIES

- * Wrench M8
- * L-Hex Key M2.5
- * L-Hex Key M4
- * Chip Guard kit
- * Coolant Tank kit
- * Safety Strap
- * MT3 Cutter Holder
- * Drift



IDENTIFICATION

Become familiar with the names and locations of the controls and features shown below to better understand the instructions when mentioned later in this manual.

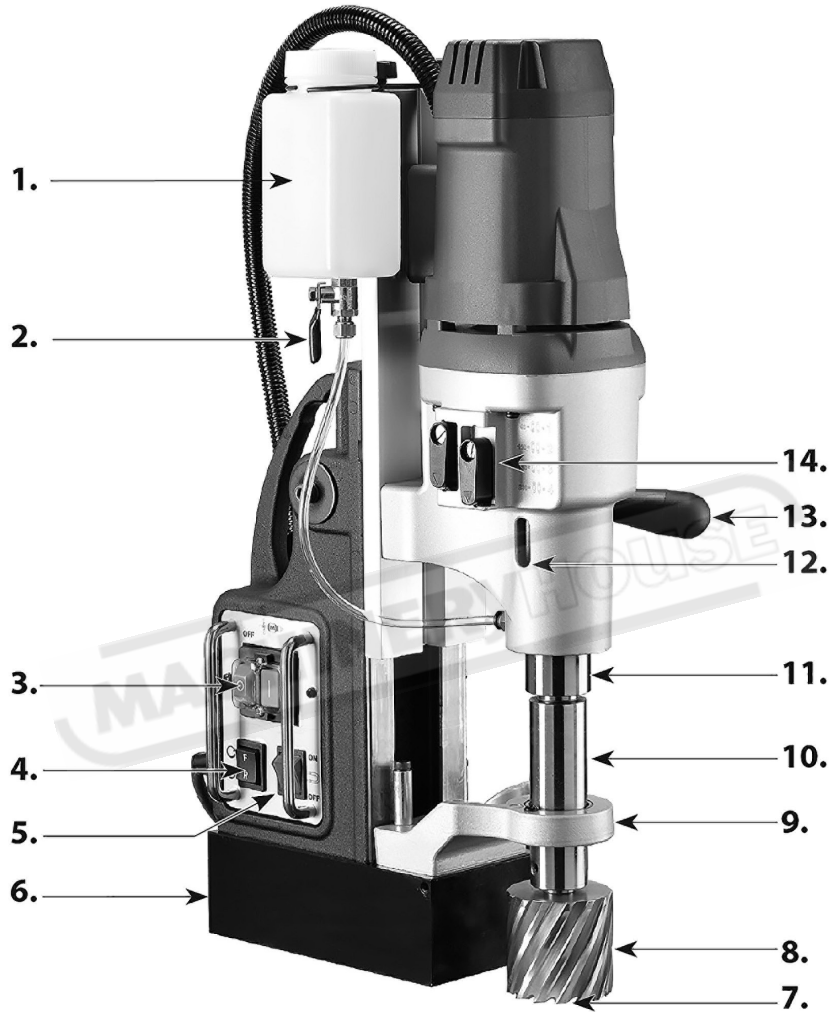

1	Coolant Tank	8	Annular Cutter (Not Included)
2	Coolant Tank Tap	9	Arbor Support Bracket
3	Motor Switch	10	Arbor
4	Reversing Switch	11	Spindle
5	Magnet Switch	12	Ejector Port
6	Magnet Base	13	Crank Handle
7	Pilot Pin (Not Included)	14	Gear Selectors

IMPORTANT INFORMATION

GENERAL POWERTOOL SAFETY



WARNING.

Read and understand the instructions in this manual, before operating this machine to reduce the risk of serious injury or even death. Save all warnings and instructions for future reference

The term “power tool” in the warnings refers to your mains-operated (corded) power tool or battery operated (cordless) power tool.

1) Work area safety

- a. Keep work area clean and well lit. Cluttered or dark areas invite accidents.
- b. Do not operate power tools in explosive atmospheres, such as in the presence of flammable liquids, gases or dust. Power tools create sparks which may ignite the dust or fumes.
- c. Keep children and bystanders away while operating a power tool. Distractions can cause you to lose control.

2) Electrical safety

- a. Power tool plugs must match the outlet. Never modify the plug in any way. Do not use any adapter plugs with earthed (grounded) power tools. Unmodified plugs and matching outlets will reduce risk of electric shock.
- b. Avoid body contact with earthed or grounded surfaces, such as pipes, radiators, ranges and refrigerators. There is an increased risk of electric shock if your body is earthed or grounded.
- c. Do not expose power tools to rain or wet conditions. Water entering a power tool will increase the risk of electric shock.
- d. Do not abuse the cord. Never use the cord for carrying, pulling or unplugging the power tool. Keep cord away from heat, oil, sharp edges or moving parts. Damaged or entangled cords increase the risk of electric shock.
- e. When operating a power tool outdoors, use an extension cord suitable for outdoor use. Use of a cord suitable for outdoor use reduces the risk of electric shock.
- f. If operating a power tool in a damp location is unavoidable, use a residual current device (RCD) protected supply. Use of an RCD reduces the risk of electric shock.

3) Personal safety

- a. Stay alert, watch what you are doing and use common sense when operating a power tool. Do not use a power tool while you are tired or under the influence of drugs, alcohol or medication. A moment of inattention while operating power tools may result in serious personal injury.
- b. Use personal protective equipment. Always wear eye protection. Protective equipment such as a dust mask, non-skid safety shoes, hard hat or hearing protection used for appropriate conditions will reduce personal injuries.
- c. Prevent unintentional starting. Ensure the switch is in the off-position before connecting to power source and/or battery pack, picking up or carrying the tool. Carrying power tools with your finger on the switch or energising power tools that have the switch on invites accidents.
- d. Remove any adjusting key or wrench before turning the power tool on. A wrench or a key left attached to a rotating part of the power tool may result in personal injury.

GENERAL POWERTOOL SAFETY CONT.

- e. Do not overreach. Keep proper footing and balance at all times. This enables better control of the power tool in unexpected situations.
- f. Dress properly. Do not wear loose clothing or jewellery. Keep your hair and clothing away from moving parts. Loose clothes, jewellery or long hair can be caught in moving parts.
- g. If devices are provided for the connection of dust extraction and collection facilities, ensure these are connected and properly used. The use of dust collection can reduce dust-related hazards.
- h. Do not let familiarity gained from frequent use of tools allow you to become complacent and ignore tool safety principles. A careless action can cause severe injury.

4) Power tool use and care

- a. Do not force the power tool. Use the correct power tool for your application. The correct power tool will do the job better and safer at the rate for which it was designed.
- b. Do not use the power tool if the switch does not turn it on and off. Any power tool that cannot be controlled with the switch is dangerous and must be repaired.
- c. Disconnect the plug from the power source and/or remove the battery pack, if detachable, from the power tool before making any adjustments, changing accessories, or storing power tools. Such preventive safety measures reduce the risk of starting the power tool accidentally.
- d. Store idle power tools out of the reach of children and do not allow persons unfamiliar with the power tool or these instructions to operate the power tool. Power tools are dangerous in the hands of untrained users.
- e. Maintain power tools and accessories. Check for misalignment or binding of moving parts, breakage of parts and any other condition that may affect the power tool's operation. If damaged, have the power tool repaired before use. Many accidents are caused by poorly maintained power tools.
- f. Keep cutting tools sharp and clean. Properly maintained cutting tools with sharp cutting edges are less likely to bind and are easier to control.
- g. Use the power tool, accessories and tool bits etc. in accordance with these instructions, taking into account the working conditions and the work to be performed. Use of the power tool for operations different from those intended could result in a hazardous situation.
- h. Keep handles and grasping surfaces dry, clean and free from oil and grease. Slippery handles and grasping surfaces do not allow for safe handling and control of the tool in unexpected situations.

5) Service

Have your power tool serviced by a qualified repair person using only identical replacement parts. This will ensure that the safety of the power tool is maintained.

TERMINOLOGY USED IN THE MANUAL

1. **Warning:** This term means that there is a risk of physical harm or death to the operator or people nearby.
2. **Caution:** This term means that there is a risk of damage to the machine, cutting tool or other equipment.
3. **Note:** These terms offer useful information relating to the operation of the machine or its maintenance.

TERMINOLOGY USED IN THE MANUAL Cont.

V.....volts

A.....amperes

Hz.....hertz

W.....watt

~.....alternating current

n_0no load speed

min^{-1}revolutions or reciprocation
per minute

warning of general danger

with electrical earth



.....read these instructions



.....always wear eye protection



.....always wear a dust mask.



.....always wear hearing protection



.....wear safety-approved hard hat



do not dispose of electric tools,
accessories and packaging together
with household waste material

DRILL SAFETY WARNINGS

- The drill must be secured. A drill that is not properly secured may move or tip over and may result in personal injury.
- The workpiece must be clamped or secured to the workpiece support. Do not drill pieces that are too small to be clamped securely. Holding the workpiece by hand during operation may result in personal injury.
- Do not wear gloves. Gloves may be entangled by the rotating parts or chips, leading to personal injury.
- Keep your hands out of the drilling area while the tool is running. Contact with rotating parts or chips may result in personal injury.
- Make sure the accessory is rotating before feeding into the workpiece. Otherwise the accessory may become jammed in the workpiece, causing unexpected movement of the workpiece and personal injury.
- When the accessory is jammed, stop applying downward pressure and switch off the tool. Investigate and take corrective actions to eliminate the cause of the jam. Jamming can cause unexpected movement of the workpiece and personal injury.
- Avoid generating long chips by regularly interrupting downward pressure. Sharp metal chips may cause entanglement and personal injuries.
- Never remove chips from the drilling area while the tool is running. To remove chips, move the accessory away from the workpiece, switch off the tool, and wait for the accessory to stop moving. Use tools such as a brush or hook to remove chips. Contact with rotating parts or chips may result in personal injury.
- Accessories with speed ratings must be rated at least equal to the maximum speed marked on the power tool. Accessories running faster than their rated speed can break and fly apart.



WARNING!

People with pacemakers should consult their physician(s) before use. Electromagnetic fields in close proximity to heart pacemaker could cause pacemaker interference or pacemaker failure.

MAGNETIC DRILL SPECIFIC SAFETY

- a. **Always use safety Strap.** Mounting can release.
- b. **WARNING:** While operating, only hold the crank handles, not any other part of the machine. Placing the hand on the machine may result in an electric shock in the event of a voltage leak or if the machine cuts its own power supply cable.
- c. **Always ensure that the work piece is a minimum of 12mm (7/16 in.) thick.** If it is not, then use a piece of steel plate at least 12mm thick and larger than the magnet, below the work piece, to supplement the magnetic adhesion. The magnet's adhesion depends on the thickness of the work piece.
- d. **Do not operate the machine on a workpiece while it is being welded.** This may lead to damage to the machine and/or personal injury.
- e. **Never position machine on a work piece between the electrode and the ground of any arc type welder.** The welder's current will ground through the earth wire in the machine's power supply cable, causing it damage.
- f. **Do not exceed 90 degrees from horizontal.** It is hazardous to use the drill upside-down.
- g. **Always ensure that the magnet is clean and free of rust and scale.** Metal chips and other debris will hamper magnetic adhesion.
- h. **Always use the tool alone on the receptacle.** Other units used on the same receptacle could cause uneven voltage that could lead to the magnet releasing.
- i. **Ensure that the magnet has properly adhered to the work piece before beginning drilling.** Proper magnet adhesion is essential for safe drilling.
- j. **When drilling non-ferrous (non-magnetic) work materials,** only use a manufacturer-approved fixture such as a vacuum base adapter. Use of accessories which are not manufacturer-approved could result in a hazardous situation.
- k. **Do not operate with dull or damaged cutting tools.** This may overload the motor.
- l. **Avoid operating annular cutters without cutting fluid.** Always check fluid level before operating. Annular cutters require cutting fluid for proper operation and long life.
- m. **Protect the motor.** Never allow cutting fluid, water, or other contaminants to enter the motor. This could lead to electric shock or motor damage.
- n. **When drilling stacked work materials,** always stop to clear the slug after the first layer is drilled. The loose slug will interfere with proper drilling.
- o. **CAUTION:** Never attempt to use machine with incorrect current or abnormally low voltage. Incorrect voltage could lead to motor damage.
- p. **This machine is not intended for production-line type use.**

MAGNET BASE DUTY CYCLE

Do not leave the magnet base activated continuously for more than 60 minutes. If the magnet base is overheated, allow it to cool for 30 minutes before continuing.

CAUTION: Turn the magnet base off when not in use. Leaving the magnet base on continuously will damage it.



WARNING!

Electricity is dangerous and could cause death

All electrical work must be carried out by a qualified electrician.

SET-UP

ASSEMBLY

Coolant tank assembly required. First attach clear tube to the bottom of the coolant tank. To do this, first loosen the nut and slide nut onto the tube. Then slide tube onto the nipple. Then tighten the nut. Slide tank hanger over the screw on the upper right hand side of slide and tighten. Finally insert the other end of the tube into the quick-release connector in the gearbox. Just directly push in to install. (To remove, first firmly push the red collar of the connector and pull the tube out.)

Cutting coolant fluid is always required when using annular cutters. Open the tank cover and fill. Check coolant fluid level often. Keep coolant tap closed when not in use.

Chip guard must be used. To attach the chip guard, use the supplied butterfly bolts to bolt to the magnet. It is not necessary to remove guard to clean chips. Simply raise guard to upper position.

Safety Strap must be used. Loop strap around the workpiece, feed strap through the power tool's handle, and tighten strap using the ratchet mechanism.

MOUNTING ANNULAR CUTTERS

CAUTION: Never use a cutting tool that is larger than the maximum rated capacity of the machine.

1. To insert an annular cutter, first insert the pilot pin into the cutter. Then slide the cutter into the arbor, align the proper flat with the locking screw(s) and tighten securely with the supplied hex wrench.

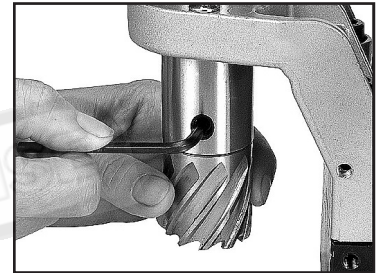

CAUTION: Ensure that the locking screw is on the flat of the cutter and not against the rounded shank.

2. Ensure that the oil feed tap is on and coolant feeds properly by pushing the pilot pin. If it feeds too quickly or slowly, adjust the tap accordingly. Keep the tap closed when not in use.

OPERATION GENERAL

WARNING: Always ensure that the magnet is adhered properly to the work piece before beginning drilling.

NOTE: If mounting to a curved surface beam, mount the machine parallel to the curve in the work piece.

WARNING: Avoid operating at more than 90 degrees from horizontal. When drilling at such an angle take precautions to prevent cutting coolant from entering the motor. Paste-type coolant should be used.

1. First fit tool into arbor and line up with intended center of cut. Then switch the magnet on.
2. To start the motor, press the green button ON. Use the crank handle to feed to work. Always use very light pressure when beginning the cut and just as the tool is breaking through. The crank handle offers tremendous leverage, so do not use too much force. Allow the cutting tool to determine the pace. With experience, the operator will be able to set the best pace of feed to the work. There should be some degree of audible slowing of the motor but not stalling in the cut.



OPERATION GENERAL Cont.

Correct cutting speed with a properly sharp annular cutter will produce long unbroken chips, which produce a “bird’s nest” shaped bundle of chips around the cut.

NOTE: Always ensure that the cutting tool is sharp. A dull cutter typically will have finer and/or choppy shavings.

WARNING: ALWAYS clear chips when there is too much build-up. Excessive chip build-up could result in a jammed cutter or other hazardous situation.

WARNING: the slug ejects at end of cut and is very hot. Always provide a method of catching the slug, where the ejected slug may cause injury to people below.

Note: Lock the slide lock on the side of the machine in the fully raised position when at rest to prevent the slide from accidentally slamming down - remember to unlock it again before commencing drilling.

CAUTION: Never attempt to cut half-circles or to stitch drill (drill overlapping holes) with a TCT cutter. This may destroy the cutter.

CAUTION: Never attempt to re enter a half-finished cut if the magnet has been turned off and the machine shifted in the interim. This may destroy the cutter.

CHANGING TOOLS & ADAPTORS WITH MT3 SHANK

To insert a tool, turn the tool until the tang lines up and firmly push into place. It is helpful to tap with a soft-faced mallet to fully engage the taper. If it is properly in position, one will not be able to pull it back apart by hand. To remove, line up the ejector slot of the arbor with the ejector port in the gear case, slide the ejector drift into the slot and tap with a hammer to eject the tool.

CAUTION: When removing, take care that the cutting tool does not crash down and get damaged or injure anyone below.

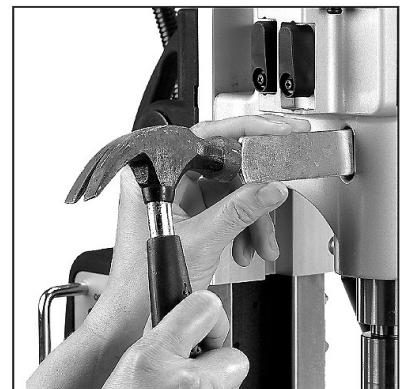

MT3 ANNULAR CUTTER ADAPTOR

This machine is equipped with a unique annular cutter adaptor system with built-in coolant directly to the gearbox. No stop bar is needed.

1. To install the annular cutter adaptor, first insert the taper end of the adaptor into the arbor of the machine as described above.
2. Attach the coolant tank to the slide and ensure that the tube is attached properly.
3. To insert an annular cutter, first insert the pilot pin. Then slide the cutter into the adaptor, align the proper flat with the locking screw(s) and tighten securely with the supplied hex wrench.
4. Ensure that the oil feed tap is on and coolant feeds properly by pushing the pilot pin. If it feeds too quickly or slowly, adjust the tap accordingly. Keep the tap closed when not in use.

OPERATION GENERAL Cont.

WARNING: NEVER operate 60mm (2-3/8 in.) or larger cutters unless the plate thickness is minimum 20mm (13/16 in.) **MAGNET LIFTING MAY RESULT.** If the plate thickness is not enough, supplement the magnetic adhesion by adding a 10mm or thicker plate directly beneath the magnet's position under the work piece.

CAUTION: Machine is equipped with a reversing switch. Always ensure that direction of rotation is correct before operating. Operating in the wrong direction could result in damage to the cutter.

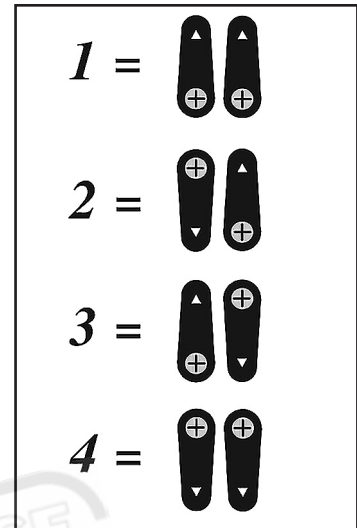

SPEED SELECTION

Select desired gear range by first popping the tab out of its detent and then sliding selectors up or down in the proper combination. Refer to the chart to achieve the correct combination for the desired speed. (It may be necessary to turn the arbor slightly in order for the gears to mesh properly). Follow the recommended speed ranges on the cutting speed chart to set the proper speed and gear range.

GEAR	NO LOAD min ¹	FULL LOAD min ¹	CUTTER SIZE	TAPING SIZE
1	150	90	60 ~ 75mm (2-3/8" ~ 3")	15 ~ 25.4mm (or less) (9/16" ~ 1")
2	200	120	45 ~ 60mm (1-3/4" ~ 2-3/8")	N/A
3	300	180	35 ~ 45mm (1-3/8" ~ 1-3/4")	N/A
4	380	230	35mm or less (1-3/8")	N/A

NOTE: These speeds are general recommendations only. The material should determine actual speeds and the cutting speed recommended by the cutting tool manufacturer. See the section below

"RECOMMENDED SURFACE SPEEDS" and use the formula to calculate the best RPM.

NOTE: the left and right side gear selectors have a different engagement design:

For The LEFT HAND SLIDER must ALWAYS ensure that the machine is FULLY STOPPED before attempting to change gears! NEVER change the Left hand slider gears on a running machine!

For the RIGHT HAND SLIDER the gears select by engagement dogs, similar to a motor cycle transmission design. These MUST BE SELECTED BY TURNING THE ARBOR to allow the dogs to engage.

CAUTION: Ensure that that gears engage fully.

AVOID OVERHEATING THE MOTOR

When using the machine at or near maximum capacity the motor will be at maximum stress and very hot. After each cut is finished, **ALWAYS** cool the motor by running at no load for a few minutes

CUTTING SPEEDS

The type of material to be drilled, its hardness and thickness will all greatly affect the recommended cutting speed. See the chart below for general guidelines for cutting speeds. Use the formula to determine the recommended RPM for the diameter of annular cutter being used:

RECOMMENDED SURFACE SPEEDS

Note: work materials which have been flame cut will be heat treated in the affected area. These areas will require much slower cutting speeds.

Work Material	Surface Speed MPM (m/min)
Aluminium	60 ~ 90
Brass	40 ~ 50
Soft Cast Iron	30 ~ 50
Hard Cast Iron	15 ~ 21
Mild Steel	24 ~ 30
High Tensile Steel	6 ~ 13
Stainless Steel	3 ~ 5

RPM = 318.5 x MPM / cutter diameter (in mm)

For example: if you are drilling mild steel with a 50mm cutter, the recommended MPM would be about 30 m/min, so the ideal RPM would be:

$$318.5 \times 30/50 = 191/\text{min}$$

But if you were drilling high tensile steel, the MPM would be about 6 m/min, so the ideal RPM would be: 318.5

$$\times 6/50 = 38/\text{min}$$

REVERSING SWITCH

Select desired direction of rotation. This switch has 3 positions: up (F) is forward, middle is neutral, and down (R) is reverse rotation.

WARNING: If the motor is switched on with the direction switch in the neutral position, the machine will not turn but will be "live", as soon as either forward or reverse is selected, the arbor will begin turning! Take due care .





CAUTION.
ROTATING CUTTER HAZARD Always keep hands clear of the cutter.
 Disconnect the power before installing or removing the cutter.

TWIST DRILLING

If twist drilling is desired, the arbor support bracket must be removed by removing the three socket-head bolts. Then an MT3 twist drill or an optional chuck adaptor arbor and chuck may be fitted. Follow the special instructions below to replace the arbor support bracket.

NOTE: A pilot hole may be necessary when drilling with larger twist drills.



ARBOR SUPPORT BRACKET REPLACEMENT

1. Replace arbor support bracket and screw in the 3 hex head bolts finger tight only (ensure that the needle bearing is clean and adequately greased.)
2. Replace the annular cutter arbor and carefully tighten the bolts evenly to ensure proper alignment.

WARNING: use extreme care to avoid contacting the rotating arbor shaft!

3. Double check to ensure that there is no binding anywhere throughout the stroke.
4. Tighten the 3 bolts.

DRILL CHUCK

If a MT3 chuck adaptor & chuck are used, then the bracket must be removed. To replace, see the instructions above under "ARBOR SUPPORT BRACKET REPLACEMENT".

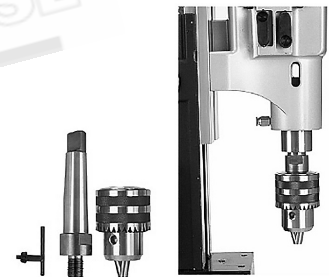

TAPPING OPERATION

CAUTION: To avoid damage to the tap, always very carefully line the tap up with the hole and ensure that the size of the hole is correct for the tap to be used.

CAUTION: To avoid damage to the tap or machine, be very careful to stop the machine in time to NOT allow the tap bottom out. The motor continues to coast for a while after being shut off, so plan for this and anticipate. This machine does NOT have a tapping clutch.

To avoid damage to the machine, ALWAYS allow the machine to come to a full stop before reversing rotation.

1. Select the proper speed according to the chart for the size of tap used.
2. Begin with forward direction of rotation with standard right hand threads. (Opposite with left-hand threads)
3. Allow the tap to determine the feed rate. A light touch on the feed handle is all that is needed once it is started in the hole. When the desired thread is tapped, hit the red motor stop switch. Allow the machine to come to a full stop. Then reverse direction and restart machine by pressing the green motor switch to remove tap. Guide the tap back out with the feed handle.

Proper order of operations for normal tapping is as follows: magnet: ON direction: forward. motor: on. motor: off. THEN: direction: reverse. motor: on. motor: off - magnet: off.



MAINTENANCE

Every 50 hours of operation blow compressed air through the motor while running at no load to clean out accumulated dust. (If operating in especially dusty conditions, perform this operation more often.)

1. Keep the machine clean and free of chips.
2. Check for loose fittings and tighten as needed.
3. Ensure that the ventilation slots are clear so that motor can be cooled normally. Blow low-pressure compressed air through the ventilation slots with the motor running to keep motor clean.

THE ARBOR SHAFT

Keep the arbor shaft free of dirt and lightly grease as needed. If the arbor support bearing is noisy, it may be dirty or have a chip lodged in it. Remove the arbor shaft to clean and re-grease the arbor support bearing.

GIB ADJUSTMENT (Dovetail Slide)

The gibes require adjustment if too loose. To adjust, loosen the lock nuts and adjust the adjustor screws evenly while moving the handle up and down. Adjust so that there is no free play, yet any binding anywhere in its range of travel. Then retighten the lock nuts. Periodically check, lubricate, and adjust as needed.



THE CARBON BRUSHES

The carbon brushes are a normal wearing part and must be replaced when they reach their wear limit.

Caution: Always replace the brushes as a pair.

To replace

1. Remove the 4 screws and remove the motor tail cover.
2. Using pliers rotate the brush spring out of the way and slide the old carbon brush out of the brush holder.
3. Unscrew the screw to remove the brush lead. The old carbon brush may now be lifted away.
4. Install a new brush. Installation is the reverse of removal.
5. Replace the motor tail cover.

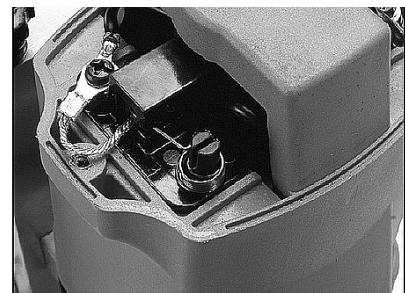

CARBON BRUSHES

Due to the brush design, if the machine comes to a stop without any reason, the brushes have to be checked. The brush design stops the machine before the carbon brushes are finished and protects the motor.

AUTO STOP CARBON BRUSH

Due to the new auto stop carbon brush if the machine comes to a stop without any reason, the brushes have to be checked. The auto feature stops the machine before the carbon brushes are finished and protects the motor.

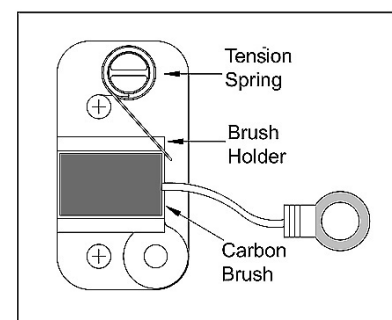

MAGNET TROUBLESHOOTING

Full magnet performance is absolutely essential for magnetic drill operation.

If the magnet works, but does not hold well, it is likely that one of the coils has failed. If the magnet does not work at all, it is likely to be a failed rectifier. (It is highly unlikely that both magnet coils would fail at the same time)

NOTE: A faulty magnet coil can also damage the rectifier, so whenever there is a magnet problem, BOTH the magnet coils and rectifier must be checked.

WARNING: Never attempt to operate a magnetic drill with a faulty magnet!

CHECKING THE MAGNET (qualified technicians only)

If the magnet is not working well, it must be checked. Separate the wires of each individual coil and test the resistance of each coil separately. (note that 110V models are wired in parallel and 230V models are wired in series) The resistance of the coils of different sizes of magnets varies, but it should be in the region of hundreds of ohms. Most importantly, both coils must have very nearly the same resistance. If one of the coils has zero resistance, it means that it is shorted. If one of the coils has infinite resistance, it means that the circuit is broken. If either coil has a problem, the magnet must be replaced. A faulty magnet may also cause damage to the rectifier. Also check the rectifier when replacing a faulty magnet. (see below)

CHECKING THE RECTIFIER (Qualified technicians only)

The rectifier takes the AC household current and converts it to DC to power the magnet. If it fails, the magnet coils will not receive power.

Disconnect the rectifier and test the resistance of both circuits of the rectifier between the AC and the DC sides.

Note that polarity matters, so you can only take a reading if test probes are oriented correctly. Each side will be the opposite of the other. Both circuits should have very nearly the same resistance reading. If one of the circuits has zero resistance, it means that it is shorted. If one of the circuits has infinite resistance, it means that the circuit is broken.

If the replacement of the power supply cord is necessary, this has to be done by the manufacturer or their agent in order to avoid a safety hazard.

WARNING: All repairs must be entrusted to an authorized service center. Incorrectly performed repairs could lead to injury or death.



CAUTION

Before attempting this feature, disconnect the machine from the power supply to avoid injury to the operator from accidental startup, injury or death to the operator.

MAGNETIC BASE DRILL

HF-750

ORDER CODE: (D9507)

EDITION : 1.0
DATE: (11/24)

The following section covers the spare parts diagrams and lists that were current at the time this manual was originally printed. Due to continuous improvements of the machine, changes may be made at anytime without notification.

HOW TO ORDER SPARE PARTS

1. Have your machines model number, serial number & date of manufacture on hand, these can be found on the specification plate mounted on the machine
2. A scanned copy of your parts list/diagram with required spare part/s identified.

NOTE: SOME PARTS MAY ONLY BE AVAILABLE AS AN ASSEMBLY

3. Go to www.machineryhouse.com.au/contactus and fill out the inquiry form attaching a copy of scanned parts list.



WARNING!

*Electricity is dangerous and could cause death
All electrical work must be carried out by a qualified electrician.*



CAUTION

It is impossible to cover all possible hazards Every workshop environment is different. These are designed as a guide to be used to compliment training and as a reminder to users prior to equipment use. Always consider safety first, as it applies to the individual working conditions.

SPARE PARTS DIAGRAM

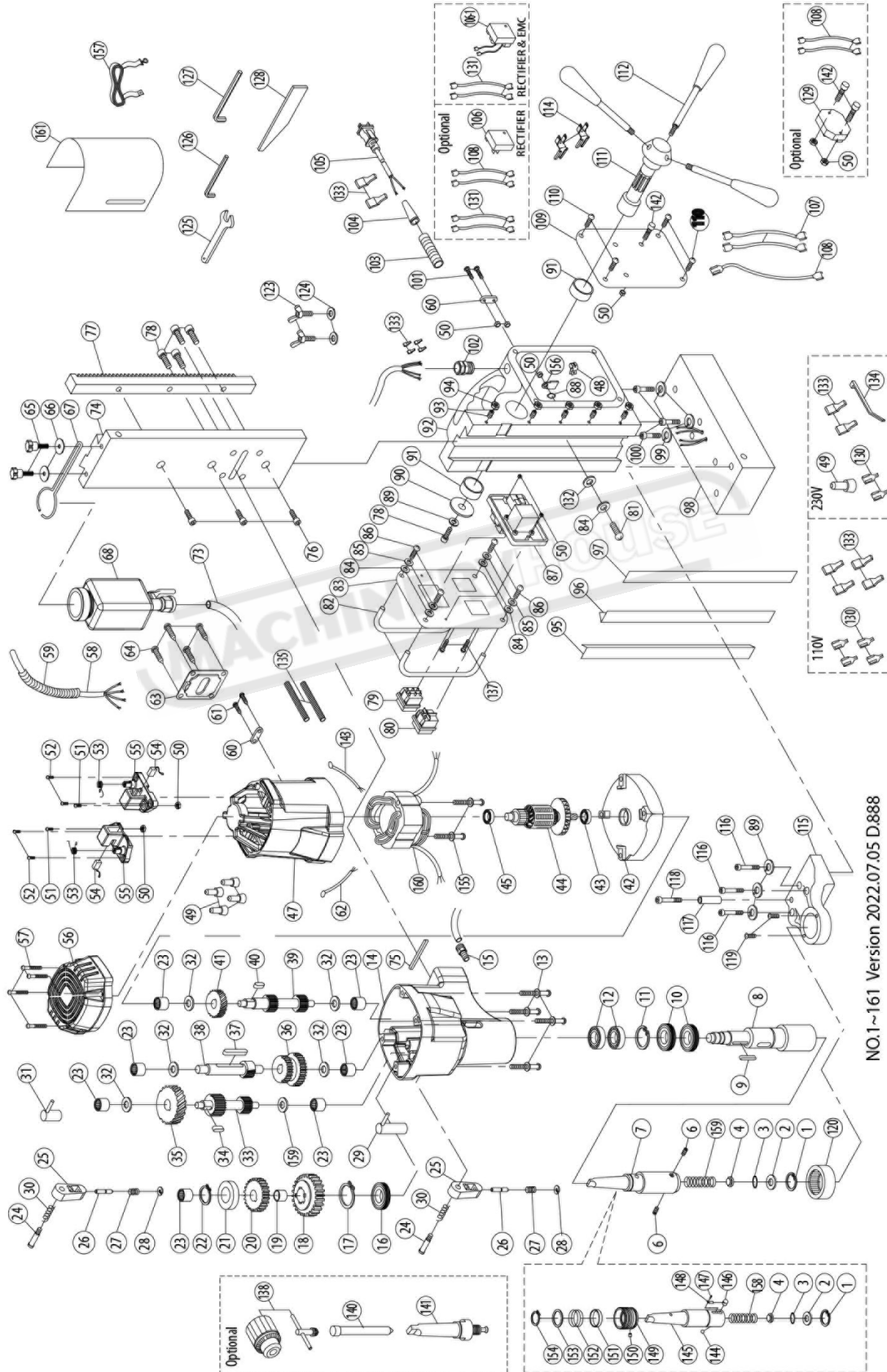

NO.1~161 Version 2022.07.05 D.888

SPARE PARTS LIST

Item	Description	Qty	Item	Description	Qty.
1	INTERNAL CIRCLIP (R-19)	1	57	PANHEAD TAPPING SCREW (M4x20)	4
2	FLAT WASHER (Ø10xØ18.5x0.8)	1	58	WIRE (2.0x4Cx86CM-SJT)	1
3	O-RING (Ø12x4)	1	59	CABLE PROTECTOR (3/8"x50CM)	1
4	WATER SEAL (Ø12x15)	1	60	CABLE CLIP	2
5	SPRING (Ø1.2xØ10xØ12.4x24Tx140L)	1	61	PANHEAD TAPPING SCREW (M4x16)	2
6	SOCKET SET SCREW (M8x7xP1.25)	2	62	WIRE LEAD (1015-16#26CM)	1
7	ARBOR (MT3-Ø19)	1	63	MOTOR COVER PLATE	1
8	SPINDLE (MT3-199.8MM)	1	64	FLAT HEAD TAPPING SCREW (M5x10)	4
9	PARALLEL KEY (5x5x40)	1	65	THUMB SCREW (M5x16)	2
10	OIL SEAL (Ø40xØ55x7)	2	66	FLAT WASHER (Ø5xØ12x1)	2
11	INTERNAL CIRCLIP (R-55)	1	67	COOLANT TANK BRACKET	1
12	BALL BEARING (6006)	2	68	COOLANT TANK ASSEMBLY	1
13	PANHEAD TAPPING SCREW (M5x65)	4	73	TUBE (Ø4xØ6x30CM)	1
14	GEAR HOUSING	1	74	SLIDE PLATE (L348MM)	1
15	PUSH LOCK FITTING (PT1/8"xØ6)	1	75	PARALLEL KEY (4x4x30)	1
16	OIL SEAL (Ø30xØ45x5)	1	76	SOCKET CAP SCREW (M8x20xP1.25)	3
17	EXTERNAL CIRCLIP (S-30)	1	77	GEAR RACK (M2.0x270L)	1
18	LOW SPINDLE GEAR (DP10/12x21T)	1	78	SOCKET CAP SCREW-PARTIAL THREAD (M8-1.25 x 16)	5
19	BUSHING (Ø18xØ20x11.5)	1	79	REVERSING SWITCH (110V&220V)	1
20	HIGH SPINDLE GEAR (M1.75x25T)	1	80	MAGNET SWITCH (110V&220V)	1
21	SPACER (Ø14.2xØ22x5)	1	81	PANHEAD MACHINE SCREW (M4x16xP0.7)	1
22	EXTERNAL CIRCLIP (S-14)	1	82	SWITCH GUARD BAR (110MM)	2
23	NEEDLE BEARING (HK 1010)	7	83	SWITCH PANEL (130.5x90.5x1.5T)	1
24	SHOULDER SCREW	2	84	FLAT WASHER (Ø4xØ10x1)	5
25	SELECTOR TAB	2	85	SPRING WASHER (M4)	4
26	DETENT PIN (Ø5x22.5)	2	86	SOCKET CAP SCREW (M4x16xP0.7)	4
27	SPRING (Ø0.6xØ5.3xØ6.5x17Lx5T)	2	87	MOTOR SWITCH (110V/220V)	1
28	E-CLIP (E-3)	2	88	EXTERNAL STAR WASHER (M5)	1
29	FIRST SELECTOR FORK (Ø12x26 / Ø4x25)	1	89	SPRING WASHER (M8)	4
30	SPRING (Ø1xØ9xØ11x11Lx4T)	2	90	FLAT WASHER (Ø8xØ40x2.5)	1
31	SECOND SELECTOR FORK (Ø12x21 / Ø4x32.2)	1	91	BUSHING (Ø32xØ38x12)	2
32	THRUST RING (1Ø24)	5	92	STAND BODY	1
33	IDLER SHAFT (M1.75x16Tx7T)	1	93	SOCKET SET SCREW (M5x25xP0.8)	5
34	PARALLEL KEY (5x5x10)	1	94	HEX NUT (M5xP0.8)	5
35	IDLER GEAR (M1.75x36T)	1	95	GIB STRIP-LEFT (308MM)	1
36	LAY GEAR (M1.25x28Tx30T)	1	96	GIB STRIP-RIGHT (308MM)	1
37	PARALLEL KEY (5x5x50)	1	97	GIB TENSIONER (308x15x1.2T)	1
38	COUNTERSHAFT (M1.25x12T)	1	98	ELECTROMAGNET (200x100x68)	1
39	INPUT SHAFT (M1.25x12Tx10T)	1	99	SPRING WASHER (M6)	3
40	PARALLEL KEY (5x5x8)	1	100	SOCKET CAP SCREW (M6x20xP1.0)	3
41	INPUT GEAR (M1.0x29T)	1	101	PANHEAD MACHINE SCREW (M4x30xP0.7)	2
42	GEAR PLATE	1	102	CABLE GLAND (3/8")	1
43	BALL BEARING (6202)	1	103	CABLE PROTECTOR (5/16"x7CM)	1
44	ARMATURE (110V/220V-94x54x45)	1	104	CORD ARMOR	1
45	BALL BEARING (6200)	1	105	POWER SUPPLY CABLE (VDE-1.5x3Cx3.5M-H05VVF)	1
47	MOTOR HOUSING (ORANGE-021C)	1	106	RECTIFIER (110&220V)	1
48	CABLE CLAMP	1	106-1	RECTIFIER & EMC (110V)/(110V&220V)	1
49	CRIMP CAP CONNECTOR (C4)	5	107	WIRE LEAD (1015-16#9CM)	2
50	HEX NUT (M4xP0.7)	10	108	WIRE LEAD (1015-16#18CM)	5
51	PANHEAD MACHINE SCREW (M4x10xP0.7)	2	109	SIDE PANEL (130.5x90.5x1.5T)	1
52	PANHEAD TAPPING SCREW (M4x12)	4	110	PANHEAD MACHINE SCREW (M4x8xP0.7)	4
53	BRUSH SPRING (0.4x4x3.5T)	2	111	CRANK SPINDLE (Ø32)	1
54	CARBON BRUSH (7x17x17)	2	112	CRANK HANDLE	3
55	BRUSH HOLDER (7x17)	2	114	THREE WIRE PUSH IN CONNECTOR	2
56	MOTOR TAIL CASTING	1	115	ARBOR SUPPORT BRACKET	1

NOTE: SOME INDIVIDUAL PARTS MAY ONLY BE AVAILABLE AS AN ASSEMBLY

SPARE PARTS LIST

Item	Description	Qty	Item	Description	Qty.
116	SOCKET CAP SCREW (M8x25xP1.25)	3	141	CHUCK ADAPTOR (MT3-5/8")	1
117	TRAVEL STOP (Ø6.5xØ12x34)	1	142	PANHEAD MACHINE SCREW (M4x25xP0.7)	3
118	SOCKET CAP SCREW (M6x45xP1.0)	1	143	WIRE LEAD (1015-16#30CM)	1
119	TRUSS HEAD MACHINE SCREW (M4x6xP0.7)	2	144	CHECK BALL (Ø8)	1
120	NEEDLE BEARING (HK 3516)	1	145	QUICK RELEASE ARBOR SHAFT (MT3)	1
123	BUTTERFLY SCREW (M6x10xP1.0)	2	146	LOCK PIN (12.3MM)/(11.7MM)	1
124	FLAT WASHER (Ø6xØ13x1)	2	147	PANHEAD MACHINE SCREW (M3x4xP0.5)	1
125	WRENCH (M8)	1	148	LOCK PIN SPRING	1
126	HEX KEY (M2.5)	1	149	QUICK-RELEASE COLLAR	1
127	HEX KEY (M4)	1	150	COLLAR PIN (Ø8)	1
128	DRIFT	1	151	RING (Ø40xØ44x9)	1
129	OVER LOAD PROTECTION (110V/220V)	1	152	SPRING (Ø2.3xØ39xØ43.6x3Tx30L)	1
130	FEMALE SPADE TERMINAL	4	153	SPRING SEAT RING (Ø35.1xØ44.5x2)	1
131	WIRE LEAD (1015-16#18CM)	2	154	EXTERNAL CIRCLIP (S-35)	1
132	RUBBER WASHER (Ø4xØ11x1)	1	155	PANHEAD TAPPING SCREW (M5x60)	2
133	SPADE TERMINAL BOOT	10	156	EARTHING MARKING	1
134	ZIP TIE (2.4x100MM)	1	157	SAFETY BELT	1
135	WIRE SLEEVE (Ø4)	2	158	SPRING (Ø1.2xØ10xØ12.4x15Tx100L)	1
137	PANHEAD MACHINE SCREW (M4x20xP0.7)	2	159	THRUST RING (Ø13xØ24x1)	1
138	CHUCK (5/8")	1	160	STATOR (110V/220V-94x54x45)	1
140	PILOT PIN (HSSx77LxØ6.34)/(HSSx103LxØ6.34)	1	161	CHIP GUARD	1
140	PILOT PIN (TCTx90LxØ7.98)/(TCTx90LxØ6.34)	1			
140	PILOT PIN (TCTx106LxØ6.34)/(TCTx108LxØ7.98)	1			

NOTE: SOME INDIVIDUAL PARTS MAY ONLY BE AVAILABLE AS AN ASSEMBLY

ELECTRICAL

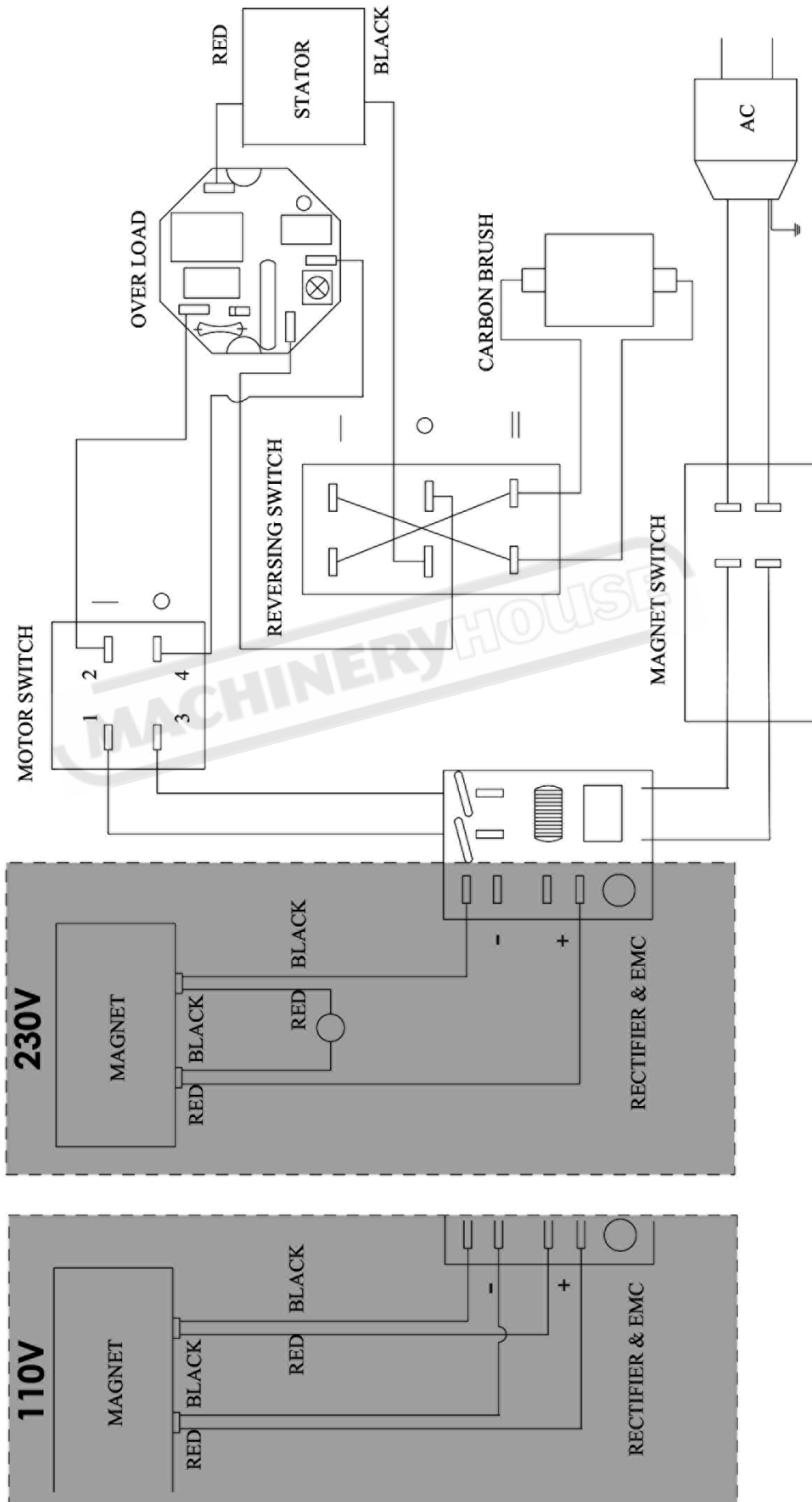

WARNING

General Machinery Safety Instructions

Machinery House
requires you to read this entire Manual before using this machine.

- 1. Read the entire Manual before starting machinery.** Machinery may cause serious injury if not correctly used.
- 2. Always use correct hearing protection when operating machinery.** Machinery noise may cause permanent hearing damage.
- 3. Machinery must never be used when tired, or under the influence of drugs or alcohol.** When running machinery you must be alert at all times.
- 4. Wear correct Clothing.** At all times remove all loose clothing, necklaces, rings, jewelry, etc. Long hair must be contained in a hair net. Non-slip protective footwear must be worn.
- 5. Always wear correct respirators around fumes or dust when operating machinery.** Machinery fumes & dust can cause serious respiratory illness. Dust extractors must be used where applicable.
- 6. Always wear correct safety glasses.** When machining you must use the correct eye protection to prevent injuring your eyes.
- 7. Keep work clean and make sure you have good lighting.** Cluttered and dark shadows may cause accidents.
- 8. Personnel must be properly trained or well supervised when operating machinery.** Make sure you have clear and safe understanding of the machine you are operating.
- 9. Keep children and visitors away.** Make sure children and visitors are at a safe distance for you work area.
- 10. Keep your workshop childproof.** Use padlocks, Turn off master power switches and remove start switch keys.
- 11. Never leave machine unattended.** Turn power off and wait till machine has come to a complete stop before leaving the machine unattended.
- 12. Make a safe working environment.** Do not use machine in a damp, wet area, or where flammable or noxious fumes may exist.
- 13. Disconnect main power before service machine.** Make sure power switch is in the off position before re-connecting.
- 14. Use correct amperage extension cords.** Undersized extension cords overheat and lose power. Replace extension cords if they become damaged.
- 15. Keep machine well maintained.** Keep blades sharp and clean for best and safest performance. Follow instructions when lubricating and changing accessories.
- 16. Keep machine well guarded.** Make sure guards on machine are in place and are all working correctly.
- 17. Do not overreach.** Keep proper footing and balance at all times.
- 18. Secure workpiece.** Use clamps or a vice to hold the workpiece where practical. Keeping the workpiece secure will free up your hand to operate the machine and will protect hand from injury.
- 19. Check machine over before operating.** Check machine for damaged parts, loose bolts, Keys and wrenches left on machine and any other conditions that may effect the machines operation. Repair and replace damaged parts.
- 20. Use recommended accessories.** Refer to instruction manual or ask correct service officer when using accessories. The use of improper accessories may cause the risk of injury.
- 21. Do not force machinery.** Work at the speed and capacity at which the machine or accessory was designed.
- 22. Use correct lifting practice.** Always use the correct lifting methods when using machinery. Incorrect lifting methods can cause serious injury.
- 23. Lock mobile bases.** Make sure any mobile bases are locked before using machine.
- 24. Allergic reactions.** Certain metal shavings and cutting fluids may cause an allergic reaction in people and animals, especially when cutting as the fumes can be inhaled. Make sure you know what type of metal and cutting fluid you will be exposed to and how to avoid contamination.
- 25. Call for help.** If at any time you experience difficulties, stop the machine and call you nearest branch service department for help.

WARNING

Metal Lathe Safety Instructions

Machinery House
requires you to read this entire Manual before using this machine.

- 1. Maintenance.** Make sure the lathe is turned off and disconnect from the main power supply and make sure all moving parts have come to a complete stop before any inspection, adjustment or maintenance is carried out.
- 2. Lathe Condition.** Lathe must be maintained for a proper working condition. Never operate a lathe that has damaged or worn parts. Scheduled routine maintenance should be performed on a scheduled basis.
- 3. Leaving a Lathe Unattended.** Always shut the lathe off and make sure all moving parts have come to a complete stop before leaving the lathe. An unsupervised running lathe can cause serious injury.
- 4. Avoiding Entanglement.** Remove loose clothing, belts, or jewelry items. Tie up long hair and use the correct hair nets to avoid any entanglement with moving parts.
- 5. Chuck key safety.** Never let go of a chuck key while still in the chuck to prevent leaving the chuck key in the chuck. Chuck keys left in the chuck can cause serious injury.
- 6. Changing Chucks.** When changing large heavy chucks they become awkward to hold. Always get assistance when installing large chucks. Use a board or piece of plywood across the bedway when any install or removal of chucks to avoid any possible finger pinching between a loose chuck and edge of a bedway.
- 7. Tooling selection.** Always use the correct cutting tool for the job you are turning. Make sure it is sharp and held firmly in the tool post. Adjust the toolpost to provide proper support for the tool you will be using.
- 8. Mounting the workpiece.** Make sure the workpiece is properly mounted and secure before turning on the lathe. A loose workpiece can be thrown across the room and cause serious injury to you or a bystander.
- 9. Workpiece clearance.** Rotate the workpiece by hand to check for clearance with the tool post, compound slide and carriage before turning the lathe on.
- 10. Changing speeds and Reversing.** Turn the lathe off and make sure the lathe has come to a complete stop before changing speeds or reversing the spindle. Do not slow or stop the lathe chuck by using your hand.
- 11. Speed selection.** Select the appropriate speed for the type of work, material, and tool bit. Allow the lathe to reach full speed before beginning a cut.
- 12. Clearing chips.** Always use a brush to clear chips. Never clear chips when the lathe is running.
- 13. Power outage.** In the event of a power failure during use of the lathe, turn off all switches to avoid possible sudden start up once power is restored.
- 14. Clean work area.** Keep the area around the lathe clean from oil, tools and chips.
- 15. Call for help.** If at any time you experience difficulties, stop the machine and call your nearest branch service department for help.

PLANT SAFETY PROGRAM

NEW MACHINERY HAZARD IDENTIFICATION, ASSESSMENT & CONTROL

Metal Lathe

Developed in Co-operation Between A.W.I.S.A and Australia Chamber of Manufactures
This program is based upon the Safe Work Australia, Code of Practice - Managing Risks of Plant in the Workplace (WHSA 2011 No10)

Item No.	Hazard Identification	Hazard Assessment	Risk Control Strategies <small>(Recommended for Purchase / Buyer / User)</small>
A	ENTANGLEMENT	HIGH	Eliminate, avoid loose clothing / Long hair etc.
C	CUTTING, STABBING, PUNCTURING	MEDIUM	Isolate power to machine prior to any checks or maintenance. Do not open or clean inside until the machine has completely stopped.
D	SHEARING	MEDIUM	Make sure all guards are secured shut when machine is on. Isolate power to machine prior to any checks or maintenance.
F	STRIKING	MEDIUM	Ensure workpiece is secured in chuck and tooling is locked tight in toolpost. Always wear safety glasses. Do not leave chuck key in chuck. Remove all loose objects around moving parts.
H	ELECTRICAL	MEDIUM	All electrical enclosures should only be opened with a tool that is not to be kept with the machine.
N	HIGH - TEMPERATURE	LOW	Machine should be installed & checked by a Licensed Electrician.
O	OTHER HAZARDS, NOISE.	LOW	Wear appropriate protective clothing to prevent hot swarf. Wear hearing protection as required.
Plant Safety Program to be read in conjunction with manufactures instructions			



www.machineryhouse.com.au



www.machineryhouse.co.nz

Authorised and signed by:
Safety officer:

Manager:

Revised Date: 12th March 2012

NOTES

MACHINERYHOUSE

MACHINERYHOUSE



ENVIRONMENT PROTECTION

Recycle unwanted materials instead of disposing of them as waste. All tools, accessories and packaging should be sorted, taken to a recycling centre and disposed of in a manner which is compatible with the environment. When the product becomes completely unserviceable and requires disposal, drain any fluids (if applicable) into approved containers and dispose of the product and fluids according to local regulations.

IMPORTED BY



Australian Distributor

**Hare & Forbes
Machineryhouse**
Sydney - Melbourne
Adelaide - Brisbane - Perth

Ph: 1300 202 200
www.machineryhouse.com.au



New Zealand Distributor

Machineryhouse
Auckland
Christchurch

Ph: 0800 142 326
www.machineryhouse.co.nz