



(Power Source)

UNIMIG

TECHNOLOGY
MITS
MIG-TIG-STICK

VRD
Voltage Reduction Device



RazorWeld

OPERATING MANUAL

KUMJR350K-SG

Please read and understand this instruction manual carefully before the installation and operation of this equipment.

Thank you for your purchase of your UNI-MIG welding machine.

We are proud of our range of welding equipment that has a proven track record of innovation, performance and reliability.

Our product range represents the latest developments in Inverter technology put together by our professional team of highly skilled engineers. The expertise gained from our long involvement with inverter technology has proven to be invaluable towards the evolution and future development of our equipment range. This experience gives us the inside knowledge on what the arc characteristics, performance and interface between man and machine should be.

Within our team are specialist welders that have a proven history of welding knowledge and expertise, giving vital input towards ensuring that our machines deliver control and performance to the utmost professional level.

We employ an expert team of professional sales, marketing and technical personnel that provide us with market trends, market feedback and customer comments and requirements. Secondly they provide a customer support service that is second to none, thus ensuring our customers have confidence that they will be well satisfied both now and in the future.

UNI-MIG welders are manufactured and compliant with - AS/NZ60974.1 2006 guaranteeing you electrical safety and performance.

WARRANTY

- 3 Years from date of purchase.
- Welding Guns Of Australia PTY LTD Ltd warranties all goods as specified by the manufacturer of those goods.
- This Warranty does not cover freight or goods that have been interfered with.
- All goods in question must be repaired by an authorised repair agent as appointed by this company.
- Warranty does not cover abuse, mis-use, accident, theft, general wear and tear.
- New product will not be supplied unless Welding Guns Of Australia PTY LTD has inspected product returned for warranty and agree's to replace product.
- Product will only be replaced if repair is not possible
- Please view full Warranty term and conditions supplied with machine or at www.unimig.com.au/warranty.asp or at the back of this manual.

CONTENTS

PAGE

Warranty.....	2
Safety	4-5
Caution, Maintenance and Trouble Shooting.....	6-7
Technical Data, Product Information.....	8-9
Machine Layout Pictogram.....	10
Installation & Operation for MMA (stick) Welding.....	11
MMA (Stick) Welding).....	12-13
Installation & Operation for MIG Welding.....	14-15
Wire Feed Drive Rollers.....	16
Wire Installation and Wire Feeder Set Up.....	17
Mig Torch Liner Installation.....	18
Torch and Wire Feeder Setup for Aluminium Wire.....	19-20
Mig Welding Guide.....	21-26
Spool Gun Setup.....	27-28
Installation & Operation for DC Tig Welding.....	29-30
DC Tig Welding.....	31-32
Tungsten Electrodes.....	33-34
MIG Torch Parts Breakdown.....	35-36
Spool Gun Torch Parts Breakdown.....	37-38
TIG Torch Parts Breakdown.....	39-40
Mig Welding Trouble Shooting Guide.....	41-42
Tig Welding Trouble Shooting Guide.....	43
MMA (Stick) Welding Trouble Shooting Guide.....	44
Machine Spare Parts Breakdown.....	45
Warranty Terms.....	46-48

SAFETY

Welding and cutting equipment can be dangerous to both the operator and people in or near the surrounding working area, if the equipment is not correctly operated. Equipment must only be used under the strict and comprehensive observance of all relevant safety regulations.

Read and understand this instruction manual carefully before the installation and operation of this equipment.

Machine Operating Safety

- Do not switch the function modes while the machine is operating. Switching of the function modes during welding can damage the machine. Damage caused in this manner will not be covered under warranty.
- Disconnect the electrode-holder cable from the machine before switching on the machine, to avoid arcing should the electrode be in contact with the work piece.
- Operators should be trained and or qualified.



Electric shock: It can kill. Touching live electrical parts can cause fatal shocks or severe burns. The electrode and work circuit is electrically live whenever the output is on. The input power circuit and internal machine circuits are also live when power is on. In Mig/Mag welding, the wire, drive rollers, wire feed housing, and all metal parts touching the welding wire are electrically live. Incorrectly installed or improperly grounded equipment is dangerous.

- Connect the primary input cable according to Australian and New Zealand standards and regulations.
- Avoid all contact with live electrical parts of the welding circuit, electrodes and wires with bare hands.
- The operator must wear dry welding gloves while he/she performs the welding task.
- The operator should keep the work piece insulated from himself/herself.
- Keep cords dry, free of oil and grease, and protected from hot metal and sparks.
- Frequently inspect input power cable for wear and tear, replace the cable immediately if damaged, bare wiring is dangerous and can kill.
- Do not use damaged, under sized, or badly joined cables.
- Do not drape cables over your body.
- We recommend (RCD) safety switch is used with this equipment to detect any leakage of current to earth.



Fumes and gases are dangerous. Smoke and gas generated whilst welding or cutting can be harmful to people's health. Welding produces fumes and gases. Breathing these fumes and gases can be hazardous to your health.

Do not breathe the smoke and gas generated whilst welding or cutting, keep your head out of the fumes

- Keep the working area well ventilated, use fume extraction or ventilation to remove welding fumes and gases.
- In confined or heavy fume environments always wear an approved air-supplied respirator.
- Welding fumes and gases can displace air and lower the oxygen level causing injury or death. Be sure the breathing air is safe.
- Do not weld in locations near de-greasing, cleaning, or spraying operations. The heat and rays of the arc can react with vapours to form highly toxic and irritating gases.
- Materials such as galvanized, lead, or cadmium plated steel, containing elements that can give off toxic fumes when welded. Do not weld these materials unless the area is very well ventilated, and or wearing an air supplied respirator.



Arc rays: harmful to people's eyes and skin. Arc rays from the welding process produce intense visible and invisible ultraviolet and infrared rays that can burn eyes and skin.

Always wear a welding helmet with correct shade of filter lens and suitable protective clothing including welding gloves whilst the welding operation is performed.

- Measures should be taken to protect people in or near the surrounding working area. Use protective screens or barriers to protect others from flash, glare and sparks; warn others not to watch the arc.



Fire hazard. Welding on closed containers, such as tanks, drums, or pipes, can cause them to explode. Flying sparks from the welding arc, hot work piece, and hot equipment can cause fires and burns. Accidental contact of electrode to metal objects can cause sparks, explosion, overheating, or fire. Check and be sure the area is safe before doing any welding.

- The welding sparks & spatter may cause fire, therefore remove any flammable materials well away from the working area. Cover flammable materials and containers with approved covers if unable to be moved from the welding area.
- Do not weld on closed containers such as tanks, drums, or pipes, unless they are properly prepared according to the required Safety Standards to insure that flammable or toxic vapours and substances are totally removed, these can cause an explosion even though the vessel has been "cleaned". Vent hollow castings or containers before heating, cutting or welding. They may explode.
- Do not weld where the atmosphere may contain flammable dust, gas, or liquid vapours (such as petrol)
- Have a fire extinguisher nearby and know how to use it. Be alert that welding sparks and hot materials from welding can easily go through small cracks and openings to adjacent areas. Be aware that welding on a ceiling, floor, bulkhead, or partition can cause fire on the hidden side.



Gas Cylinders. Shielding gas cylinders contain gas under high pressure. If damaged, a cylinder can explode. Because gas cylinders are normally part of the welding process, be sure to treat them carefully. CYLINDERS can explode if damaged.

- Protect gas cylinders from excessive heat, mechanical shocks, physical damage, slag, open flames, sparks, and arcs.
- Insure cylinders are held secure and upright to prevent tipping or falling over.
- Never allow the welding electrode or earth clamp to touch the gas cylinder, do not drape welding cables over the cylinder.
- Never weld on a pressurised gas cylinder, it will explode and kill you.
- Open the cylinder valve slowly and turn your face away from the cylinder outlet valve and gas regulator.



Gas build up. The build up of gas can causes a toxic environment, deplete the oxygen content in the air resulting in death or injury. Many gases use in welding are invisible and odourless.

- Shut off shielding gas supply when not in use.
- Always ventilate confined spaces or use approved air-supplied respirator.



Electronic magnetic fields. MAGNETIC FIELDS can affect Implanted Medical Devices.

- Wearers of Pacemakers and other Implanted Medical Devices should keep away.
- Implanted Medical Device wearers should consult their doctor and the device manufacturer before going near any electric welding, cutting or heating operation.



Noise can damage hearing. Noise from some processes or equipment can damage hearing.

- Wear approved ear protection if noise level is high.



Hot parts. Items being welded generate and hold high heat and can cause severe burns.

Do not touch hot parts with bare hands. Allow a cooling period before working on the welding gun. Use insulated welding gloves and clothing to handle hot parts and prevent burns.

CAUTION

1. Working Environment.

- i. The environment in which this welding equipment is installed must be free of grinding dust, corrosive chemicals, flammable gas or materials etc, and at no more than maximum of 80% humidity.
- ii. When using the machine outdoors protect the machine from direct sun light, rain water and snow etc; the temperature of working environment should be maintained within -10°C to +40°C.
- iii. Keep this equipment 30cm distant from the wall.
- iv. Ensure the working environment is well ventilated.

2. Safety Tips.

i. Ventilation

This equipment is small-sized, compact in structure, and of excellent performance in amperage output. The fan is used to dissipate heat generated by this equipment during the welding operation. Important: Maintain good ventilation of the louvers of this equipment. The minimum distance between this equipment and any other objects in or near the working area should be 30 cm. Good ventilation is of critical importance for the normal performance and service life of this equipment.

ii. Thermal Overload protection.

Should the machine be used to an excessive level, or in high temperature environment, poorly ventilated area or if the fan malfunctions the Thermal Overload Switch will be activated and the machine will cease to operate. Under this circumstance, leave the machine switched on to keep the built-in fan working to bring down the temperature inside the equipment. The machine will be ready for use again when the internal temperature reaches safe level.

iii. Over-Voltage Supply

Regarding the power supply voltage range of the machine, please refer to "Main parameter" table. This equipment is of automatic voltage compensation, which enables the maintaining of the voltage range within the given range. In case that the voltage of input power supply amperage exceeds the stipulated value, it is possible to cause damage to the components of this equipment. Please ensure your primary power supply is correct.

- iv. Do not come into contact with the output terminals while the machine is in operation. An electric shock may possibly occur.

MAINTENANCE

Exposure to extremely dusty, damp, or corrosive air is damaging to the welding machine. In order to prevent any possible failure or fault of this welding equipment, clean the dust at regular intervals with clean and dry compressed air of required pressure.

Please note that: lack of maintenance can result in the cancellation of the guarantee; the guarantee of this welding equipment will be void if the machine has been modified, attempt to take apart the machine or open the factory-made sealing of the machine without the consent of an authorized representative of the manufacturer.

TROUBLE SHOOTING

Caution: Only qualified technicians are authorized to undertake the repair of this welding equipment. For your safety and to avoid Electrical Shock, please observe all safety notes and precautions detailed in this manual.

Note: Minimum Motor Generator Power Suggested:- 20KVA

ATTENTION! - CHECK FOR GAS LEAKAGE

At initial set up and at regular intervals we recommend to check for gas leakage

Recommended procedure is as follows:

1. Connect the regulator and gas hose assembly and tighten all connectors and clamps.
2. Slowly open the cylinder valve.
3. Set the flow rate on the regulator to approximately 8-10 L/min.
4. Close the cylinder valve and pay attention to the needle indicator of the contents pressure gauge on the regulator, if the needle drops away towards zero there is a gas leak. Sometimes a gas leak can be slow and to identify it will require leaving the gas pressure in the regulator and line for an extended time period. In this situation it is recommended to open the cylinder valve, set the flow rate to 8-10 L/min, close the cylinder valve and check after a minimum of 15 minutes.
5. If there is a gas loss then check all connectors and clamps for leakage by brushing or spraying with soapy water, bubbles will appear at the leakage point.
6. Tighten clamps or fittings to eliminate gas leakage.

IMPORTANT! - We strongly recommend that you check for gas leakage prior to operation of your machine. We recommend that you close the cylinder valve when the machine is not in use.

Welding Guns Of Australia PTY LTD, authorised representatives or agents of Welding Guns Of Australia PTY LTD will not be liable or responsible for the loss of any gas.

UNIMIG 350 COMPACT

MIG/TIG/MMA - 350 Amp DC Inverter Welder

Welds: Steels, Stainless, Cast Iron, Bronze, Aluminium, Copper



Features

- ✓ Latest IGBT inverter technology
- ✓ Mig/Mag with Gas and Gasless wire function
- ✓ Spool Gun connection
- ✓ Stick electrode (MMA) function
- ✓ DC Tig welding with Lift Arc start
- ✓ VRD safety for Stick welding
- ✓ Wire inch & burn back control
- ✓ Industrial application
- ✓ Internal 2 roll geared wire feeder
- ✓ Euro style mig torch connection
- ✓ IP21S rating for environmental/ safety protection
- ✓ Stepless voltage and wire feed control
- ✓ Excellent mig welding with CO2 gas
- ✓ Excellent arc stability for Mig/ MMA/ TIG welding

Technical Data

Power Supply / Phases (V-Ph)	415 -3 +/- 15%
Duty Cycle @ 40°C as per AS/NZ60974	40% @ 350 Amps MIG 40% @ 350 Amps MMA
Duty Cycle @ 25°C (approximate)	70% @ 350 Amps MIG 70% @ 350 Amps MMA
Output Current Range MIG	40A - 350A
Output Current Range MMA	20A - 350A
Output Voltage Range	15-38V
Rated Power MIG	13.9 KVA
Rated Power MMA	15.0 KVA
I Max MIG	19.4 Amps
I Max MMA	20.9 Amps
I_{ieff} MIG	12.3 Amps
I_{ieff} MMA	13.2 Amps
Wire Feeder Type	Gear Driven 4 Roll
Wire Speed Range	1.5 - 15m/min
Efficiency	85%
Protection Class	IP 21S
Dimensions (LxWxH)	900x400x670mm
Weight	60 Kg
Warranty	3 years on machine



Overview

The KUMJR350K is an inverter-based multi-function Mig welding machine with added MMA and Tig function. The Mig function allows you to weld with both Gas Shielded and Gasless wire applications. Easy step less adjustment of voltage and wire feed make for easy setting of welding parameters giving excellent, professional welding results. Wire inch gives easy feeding of the wire during set up without gas wastage and the Burn Back adjustment leaves the wire stick out ready for the next weld. An additional feature is the Spoolgun ready function that allows the simple connection of the PLSP240 Spoolgun for the use of thin or softer wires that don't have the column strength to feed through standard mig torches, such as aluminium wire. Added MMA welding capability delivers easy and high quality welding using electrodes, including cast Iron, stainless and low hydrogen. Connection of the 26V tig torch provides quality DC Tig with Lift Arc start for welding of steel, stainless steel and copper. The machine is industrial rated and of solid construction, large industrial wheels allows easy and smooth manoeuvrability. Ideal for general engineers, maintenance workshop, rural workshop, tafe colleges panel beaters. Designed and built to our specification. Certified to - AS/NZ60974.1

MACHINE PACKAGE: KUMJR50K-SG

Standard Package includes: KUMJR350K Machine, Mig Torch x 4m, Earth Lead & Arc Lead 35mm x 4m, Regulator, 2M gas hose



Front Machine Layout Description

FRONT PANEL LAYOUT

1. Amperage Meter
2. Voltage Meter
3. Wire Inch Button
4. Mig/MMA/Tig Mode Selector Switch
5. Wire Feed Adjustment Knob (MIG/MAG)
6. Standard Mig / Spoolgun Selector Switch
7. "-" Output terminal
8. SpoolGun Power Supply Connection
9. "+" Output terminal
10. Euro Mig Torch Connector (MIG/MAG)
11. Voltage Adjustment Knob (MIG/MAG)
12. Amperage Adjustment Knob (MMA/TIG)
13. Thermal Overload LED
14. Mains Power LED
15. VRD LED
16. Gas Check / Weld Mode Selector Switch
17. Inductance Adjustment Knob



BACK PANEL LAYOUT

18. Input power cable
19. Power switch
20. Fan
21. Data Plate
22. Gas Inlet



INTERNAL PANEL LAYOUT

23. Burn back control
24. Spool holder assembly
25. Wire feeder mechanism

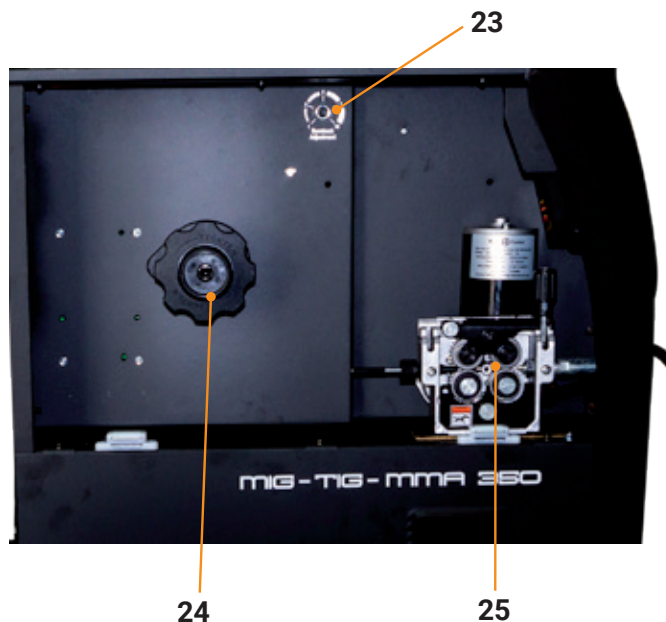

Installation set up for MMA (Stick) Welding with UNI-MIG-MIG350MTS

1. Turn the power source on and select the **MMA** function with the Tig/MMA/Mig selector switch.
2. **Connection of Output Cables**
Two sockets are available on this welding machine. For MMA welding the electrode holder is shown be connected to the positive socket, while the earth lead (work piece) is connected to the negative socket, this is known as DC+ polarity. However various electrodes require a different polarity for optimum results and careful attention should be paid to the polarity, refer to the electrode manufacturers information for the correct polarity.
DC+ Electrode connected to (+) output socket.
DC- Electrode connected to (-) output socket.
3. Set the welding current relevant to the electrode type and size being used as recommended by the electrode manufacturer.



(3) Set the welding current using the amperage control dial.



(4) Place the electrode into the electrode holder and clamp tight.



(5) Strike the electrode against the workpiece to create an arc and hold the electrode steady to maintain the arc.



(6) Hold the electrode slightly above the work maintaining the arc while travelling at an even speed.



(7) To finish the weld, break the arc by quickly snapping the electrode away from the work piece.

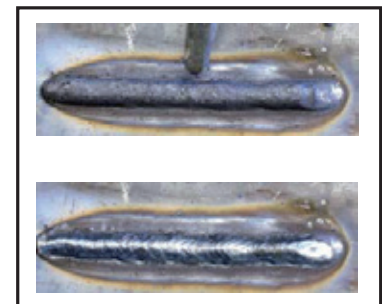

(8) Wait for the weld to cool and carefully chip away the slag to reveal the weld metal below.

MMA (Manual Metal Arc) Welding

One of the most common types of arc welding is manual metal arc welding (MMA) or stick welding. An electric current is used to strike an arc between the base material and a consumable electrode rod or 'stick'. The electrode rod is made of a material that is compatible with the base material being welded and is covered with a flux that gives off gaseous vapours that serve as a shielding gas and providing a layer of slag, both of which protect the weld area from atmospheric contamination. The electrode core itself acts as filler material the residue from the flux that forms a slag covering over the weld metal must be chipped away after welding.

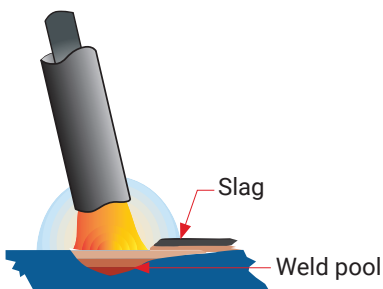
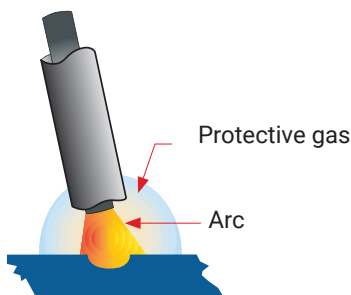
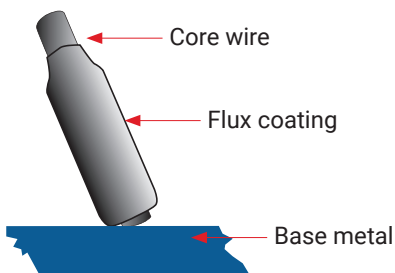
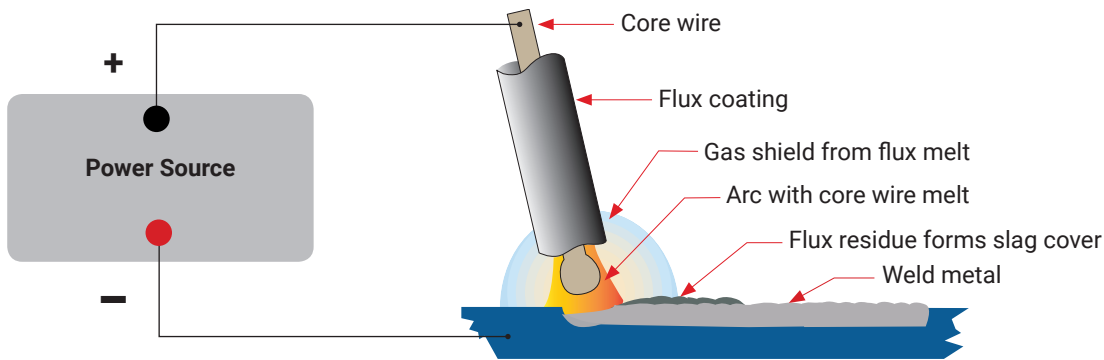

- The arc is initiated by momentarily touching the electrode to the base metal.
- The heat of the arc melts the surface of the base metal to form a molten pool at the end of the electrode.
- The melted electrode metal is transferred across the arc into the molten pool and becomes the deposited weld metal.
- The deposit is covered and protected by a slag which comes from the electrode coating.

• The arc and the immediate area are enveloped by an atmosphere of protective gas

Manual metal arc (stick) electrodes have a solid metal wire core and a flux coating. These electrodes are identified by the wire diameter and by a series of letters and numbers. The letters and numbers identify the metal alloy and the intended use of the electrode.

The **Metal Wire Core** works as conductor of the current that maintains the arc. The core wire melts and is deposited into the welding pool.

The covering on a shielded metal arc welding electrode is called Flux.

The flux on the electrode performs many different functions.

These include:

- producing a protective gas around the weld area
- providing fluxing elements and deoxidizers
- creating a protective slag coating over the weld as it cools
- establishing arc characteristics
- adding alloying elements.

Covered electrodes serve many purposes in addition to adding filler metal to the molten pool. These additional functions are provided mainly by the covering on the electrode.

MMA (Stick) Welding Fundamentals

Electrode Selection

As a general rule, the selection of an electrode is straight forward, in that it is only a matter of selecting an electrode of similar composition to the parent metal. However, for some metals there is a choice of several electrodes, each of which has particular properties to suit specific classes of work. It is recommended to consult your welding supplier for the correct selection of electrode.

Electrode Size

Average Thickness of Material	Maximum Recommended Electrode Diameter
1.0 - 2.0mm	2.5mm
2.0 - 5.0mm	3.2mm
5.0 - 8.0mm	4.0mm
8.0 - > mm	5.0mm

The size of the electrode generally depends on the thickness of the section being welded, and the thicker the section the larger the electrode required. The table gives the maximum size of electrodes that may be used for various thicknesses of section based on using a general purpose type 6013 electrode.

Welding Current (Amperage)

Electrode Size ø mm	Current Range (Amps)
2.5mm	60 - 100
3.2mm	100 - 130
4.0mm	130 - 165
5.0mm	165 - 260

Correct current selection for a particular job is an important factor in arc welding. With the current set too low, difficulty is experienced in striking and maintaining a stable arc. The electrode tends to stick to the work, penetration is poor and beads with a distinct rounded profile will be deposited. Too high current is accompanied by overheating of the electrode resulting in undercut and burning through of the base metal and producing excessive spatter. Normal current for a particular job may be considered as the maximum, which can

be used without burning through the work, over-heating the electrode or producing a rough spattered surface.

The table shows current ranges generally recommended for a general purpose type 6013 electrode.

Arc Length

To strike the arc, the electrode should be gently scraped on the work until the arc is established. There is a simple rule for the proper arc length; it should be the shortest arc that gives a good surface to the weld. An arc too long reduces penetration, produces spatter and gives a rough surface finish to the weld. An excessively short arc will cause sticking of the electrode and result in poor quality welds. General rule of thumb for down hand welding is to have an arc length no greater than the diameter of the core wire.

Electrode Angle

The angle that the electrode makes with the work is important to ensure a smooth, even transfer of metal. When welding in down hand, fillet, horizontal or overhead the angle of the electrode is generally between 5 and 15 degrees towards the direction of travel. When vertical up welding the angle of the electrode should be between 80 and 90 degrees to the work piece.

Travel Speed

The electrode should be moved along in the direction of the joint being welded at a speed that will give the size of run required. At the same time, the electrode is fed downwards to keep the correct arc length at all times. Excessive travel speeds lead to poor fusion, lack of penetration etc, while too slow a rate of travel will frequently lead to arc instability, slag inclusions and poor mechanical properties.

Material and Joint Preparation

The material to be welded should be clean and free of any moisture, paint, oil, grease, mill scale, rust or any other material that will hinder the arc and contaminate the weld material. Joint preparation will depend on the method used include sawing, punching, shearing, machining, flame cutting and others. In all cases edges should be clean and free of any contaminants. The type of joint will be determined by the chosen application.

Installation set up for MIG Welding with UNI-MIG-MIG350MTS

1. Select the MIG function with the Tig/MMA/Mig selector switch.
2. Select Standard using the Standard/Spool Gun selector switch.
3. Plug the welding torch into the Euro Mig torch connection socket on the front panel, and tighten it.
4. Insert the earth cable plug into the required polarity and tighten - negative for gas shielded wires positive for gas less wires. The weld power cable goes into the opposing negative or positive socket.
5. Connect Gas Line to Gas Regulator and connect the gas regulator to the Gas Cylinder.
6. Fit the correct type and size of drive rollers.V Groove for Hard Wires. U Groove for Aluminium. Knurled for Flux Cored
7. Place the Wire Spool onto the Spool Holder - Note: the spool retaining nut is Left Hand thread. Snip the wire from the spool being sure to hold the wire to prevent rapid uncoiling. Feed the wire into the wire feeder inlet guide tube through to the drive roller.
8. Carefully feed the wire over the drive roller into the outlet guide tube, feed through about 150mm into the torch receptacle. Check that the drive roller being used complies with the wire diameter, replace the roller if necessary.

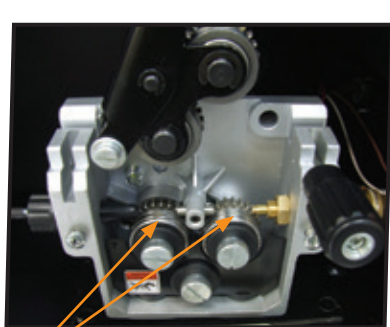

(6) Fit the correct type and size of drive rollers.V Groove for Hard Wires. U Groove for Aluminium. Knurled for Flux Cored

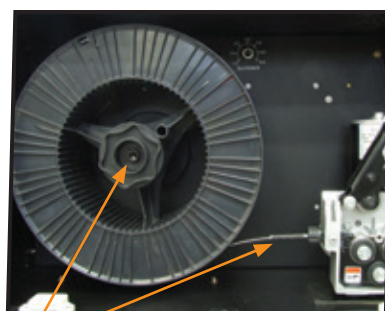

(7) Place wire onto spool holder - (spool retaining nut is left hand thread) Feed the wire through the inlet guide tube into the drive roller.

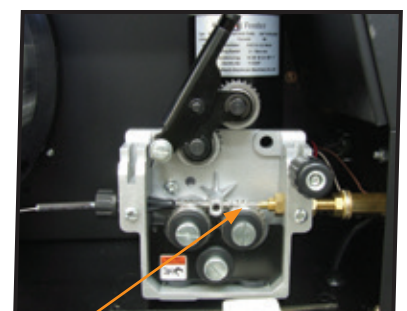

(8) Feed wire over the drive roller into the outlet guide tube, Push the wire through approx 150mm.

Continued set up for MIG Welding with UNI-MIG-MIG350MTS

- Align the wire into the groove of the drive roller and close down the top roller making sure the wire is in the groove of the bottom drive roller, lock the pressure arm into place. Apply a medium amount of pressure to the drive roller.
- Remove the gas nozzle and contact tip from the torch neck,
- Press and hold the inch button to feed the wire through to the torch neck, release the inch button when the wire exits the torch neck.
- Fit the correct sized contact tip and feed the wire through it, screw the contact tip into the tip holder of the torch head and nip it up tightly.
- Fit the gas nozzle to the torch head.
- Carefully open the gas cylinder valve and set the flow rate to between 5-10 l/min.
- Set the welding parameters using the wire feed and voltage control knobs.
- Using the **Burn Back** control set the amount of wire to 'burn back' after you release the torch trigger. This prevents the wire becoming stuck in the weld pool when finishing the weld.

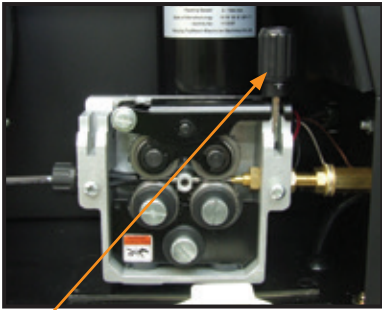

(9) Close down the top roller bracket and clip the pressure arm into place. Apply a medium amount of pressure to the drive roller



(10) Remove the gas nozzle and contact tip from the front end of the mig torch.



(11) Press and hold the inch wire button to feed the wire down the torch cable through to the torch head.

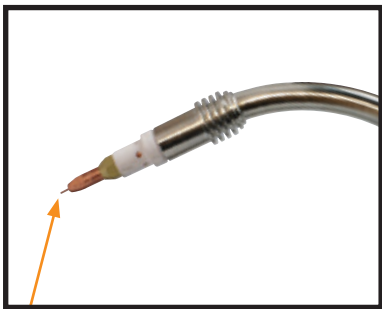

(12) Fit the correct size contact tip over the wire and fasten tightly into the tip holder.

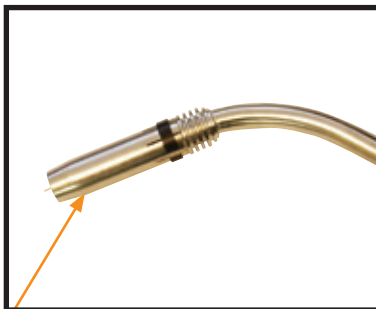

(13) Fit the gas nozzle to the torch head.

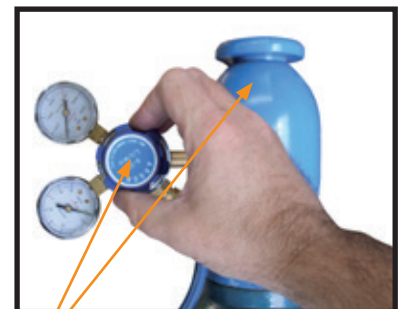

(14) Carefully open the valve of the gas cylinder, set the flow to 6-10 l/min



(15) Set welding parameters using the voltage and wire feed controls.



(16) Adjust the burn back control to prevent the wire sticking in the weld pool. Burn back control is located above the wire feed motor

Wire Feed Roller Selection

The importance of smooth consistent wire feeding during MIG welding cannot be emphasized enough.

Simply put the smoother the wire feed then the better the welding will be.

Feed rollers or drive rollers are used to feed the wire mechanically along the length of the welding gun.

Feed rollers are designed to be used for certain types of welding wire and they have different types of grooves machined in them to accommodate the different types of wire. The wire is held in the groove by the top roller of the wire drive unit and is referred to as the pressure roller, pressure is applied by a tension arm that can be adjusted to increase or decrease the pressure as required. The type of wire will determine how much pressure can be applied and what type of drive roller is best suited to obtain optimum wire feed.

Solid Hard Wire - like Steel, Stainless Steel require a drive roller with a V shape groove for optimum grip and drive capability. Solid wires can have more tension applied to the wire from the top pressure roller that holds the wire in the groove and the V shape groove is more suited for this. Solid wires are more forgiving to feed due to their higher cross sectional column strength, they are stiffer and don't bend so easy.

Soft Wire - like Aluminium requires a U shape groove. Aluminium wire has a lot less column strength, can bend easily and is therefore more difficult to feed. Soft wires can easily buckle at the wire feeder where the wire is fed into inlet guide tube of the torch. The U-shaped roller offers more surface area grip and traction to help feed the softer wire. Softer wires also require less tension from the top pressure roller to avoid deforming the shape of the wire, too much tension will push the wire out of shape and cause it to catch in the contact tip.

Flux Core / Gasless Wire - these wires are made up of a thin metal sheath that has fluxing and metal compounds layered onto it and then rolled into a cylinder to form the finished wire. The wire cannot take too much pressure from the top roller as it can be crushed and deformed if too much pressure is applied. A knurled drive roller has been developed and it has small serrations in the groove, the serrations grip the wire and assist to drive it without too much pressure from the top roller. The down side to the knurled wire feed roller on flux cored wire is it will slowly over time bit by bit eat away at the surface of the welding wire, and these small pieces will eventually go down into the liner. This will cause clogging in the liner and added friction that will lead to welding wire feed problems. A U groove wire can also be used for flux core wire without the wire particles coming of the wire surface. However it is considered that the knurled roller will give a more positive feed of flux core wire without any deformation of the wire shape.

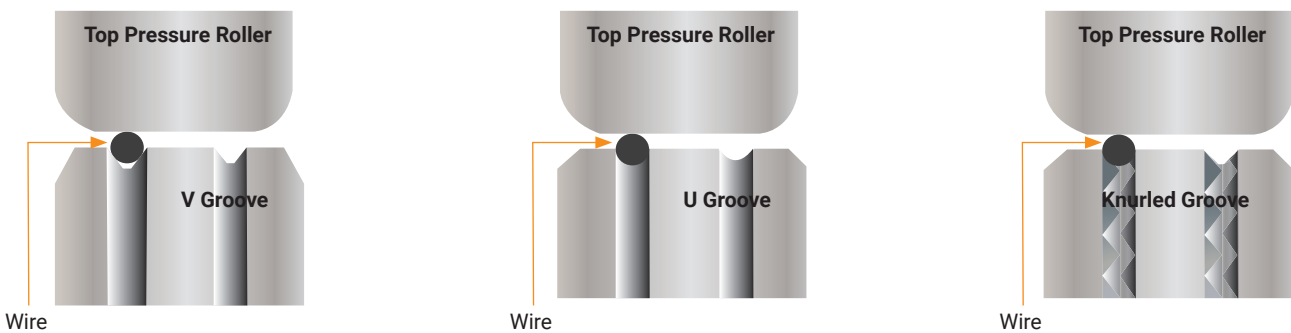

Drive Rollers

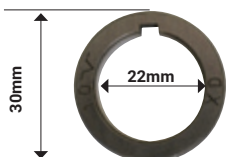

V Groove Drive Roller - Steel Wire

Part Number	Description
0.6-0.8V30/22	Drive Roll V Groove 0.6-0.8mm
0.6-1.2V30/22	Drive Roll V Groove 0.6-1.2mm
0.8-1.0V30/22	Drive Roll V Groove 0.8-1.0mm
0.8-1.2V30/22	Drive Roll V Groove 0.8-1.2mm
0.9-1.0V30/22	Drive Roll V Groove 0.9-1.0mm
0.9-1.2V30/22	Drive Roll V Groove 0.9-1.2mm
1.0-1.2V30/22	Drive Roll V Groove 1.0-1.2mm
1.2-1.4V30/22	Drive Roll V Groove 1.2-1.4mm
1.2-1.6V30/22	Drive Roll V Groove 1.2-1.6mm

U Groove Drive Roller - Soft Wire

Part Number	Description
0.8-1.0U30/22	Drive Roll U Groove 0.8-1.0mm
0.9-1.0U30/22	Drive Roll U Groove 0.9-1.0mm
0.9-1.2U30/22	Drive Roll U Groove 0.9-1.2mm
1.0-1.2U30/22	Drive Roll U Groove 1.0-1.2mm

Knurled Drive Roller - Flux Core Wire

Part Number	Description
0.8-0.9F30/22	Drive Roll Knurled 0.8-0.9mm
0.9-1.2F30/22	Drive Roll Knurled 0.9-1.2mm
1.0-1.2F30/22	Drive Roll Knurled 1.0-1.2mm
1.2-1.6F30/22	Drive Roll Knurled 1.2-1.6mm

Wire Installation and Set Up Guide

Again the importance of smooth consistent wire feeding during MIG welding cannot be emphasized enough.

The correct installation of the wire spool and the wire into the wire feed unit is critical to achieving an even and consistent wire feed. A high percentage of faults with mig welders emanate from poor set up of the wire into the wire feeder. The guide below will assist in the correct setup of your wire feeder.



(1) Remove the spool retaining nut.

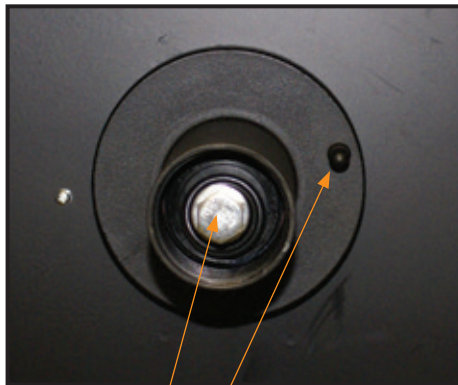

(2) Note the tension spring adjuster and spool locating pin.

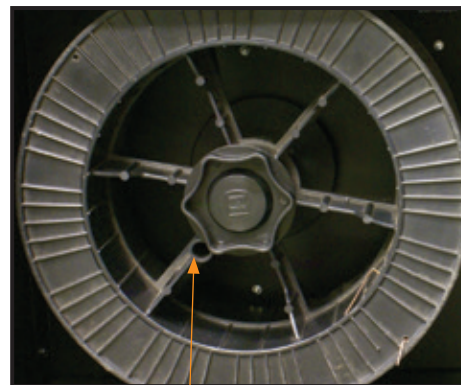

(3) Fit the wire spool onto the spool holder fitting the locating pin into the location hole on the spool. Replace the spool retaining nut tightly

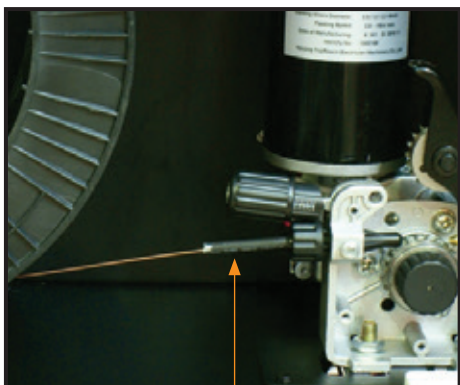

(4) Snip the wire carefully, be sure to hold the wire to prevent the spool uncoiling. Carefully feed the wire into the inlet guide tube of the wire feed unit.

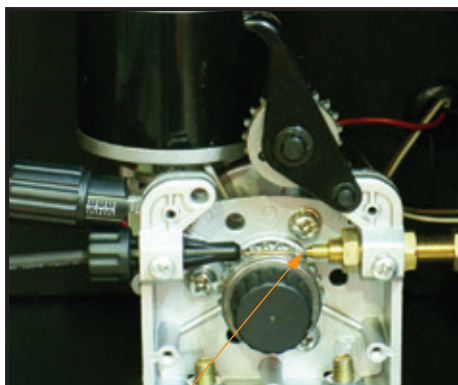

(5) Feed the wire through the drive roller and into the outlet guide tube of the wire feeder.

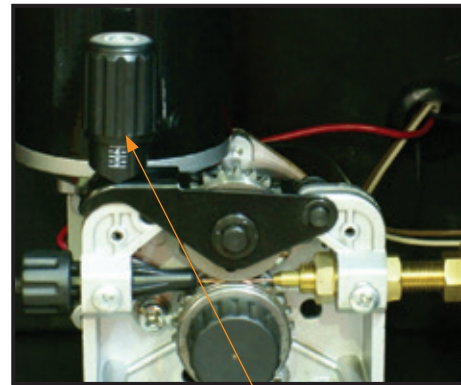

(6) Lock down the top pressure roller and apply a medium amount of pressure using the tension adjustment knob

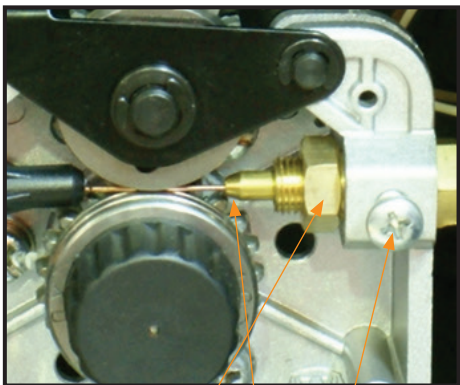

(7) Check that the wire passes through the centre of the outlet guide tube without touching the sides. Loosen the locking screw and then loosen the outlet guide tube retaining nut too make adjustment if required. Carefully retighten the locking nut and screw to hold the new position.



(8) A simple check for the correct drive tension is to bend the end of the wire over hold it about 100mm from your hand and let it run into your hand, it should coil round in your hand without stopping and slipping at the drive rollers, increase the tension if it slips.



(8) The weight and speed of the wire spool turning creates an inertia that can cause the spool to run on and the wire loop over the side of the spool and tangle. If this happens increase the pressure on the tension spring inside the spool holder assembly using the tension adjustment screw.

Mig Torch Liner Installation

1. Lay the torch out straight on the ground and remove the front end parts
2. Remove the liner retaining nut.
3. Carefully pull the liner out of the torch cable assembly
4. Select the correct new liner and carefully unravel avoiding putting any kinks in the liner, if you kink the liner it will make it no good and will require replacement.
5. Carefully and slowly feed the liner in short forward movements down the cable assembly all the way through and out the torch neck end. Avoid kinking the liner, kinking liner it will make it no good and require replacement.
6. Fit the liner retaining nut and screw down only 1/2 way
7. Leaving the torch straight snip the liner approximately 3mm past the end of the torch neck
8. Place the tip holder over the end of the liner and screw into the torch neck nipping it up tight.
9. Screw down the liner nut the remaining 1/2 and nip it up tight. This method compresses the liner inside the torch cable assembly preventing it moving during use and ensures good wire feed.



(1) Remove mig torch front end parts

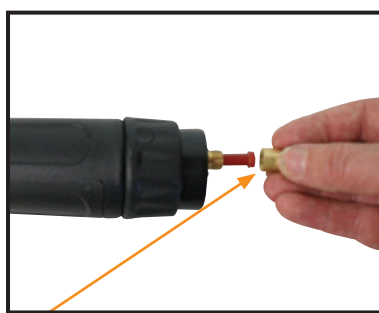

(2) Remove the liner retaining nut

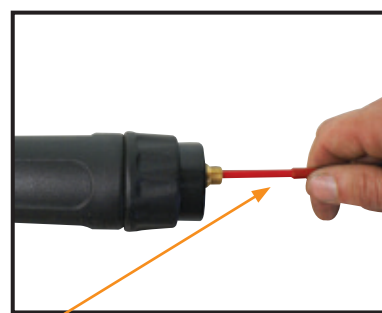

(3) Carefully pull out and completely remove the liner

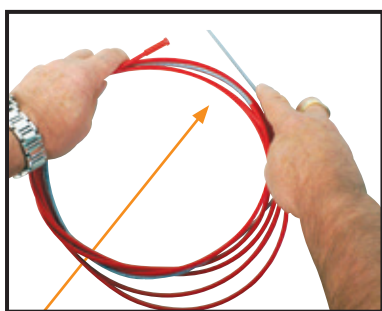

(4) Carefully unravel the new liner

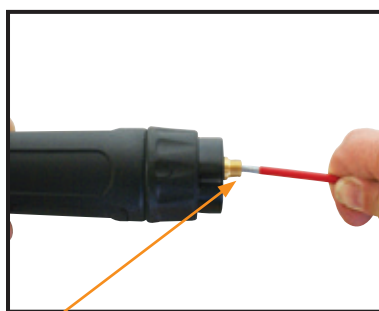

(5) Carefully feed in the new liner down the torch lead all the way to exit the torch neck.

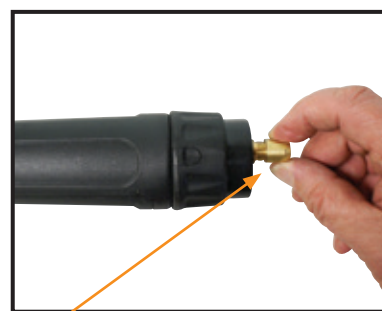

(6) Fit the liner retaining nut and screw only 1/2 way down

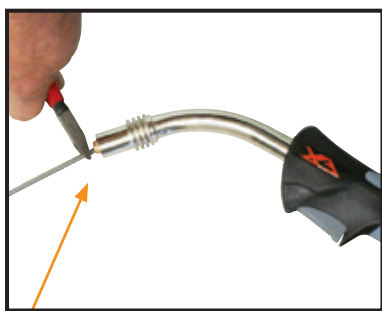

(7) Snip the liner off 3mm past the end of the torch neck.



(8) Replace the front end parts



(9) Fully screw down the liner retaining nut and nip it up tight.

Torch & Wire Feed Set Up for Aluminium Wire

1. Lay the torch out straight on the ground and remove the front end parts
2. Remove the liner retaining nut.
3. Carefully pull the liner out of the torch cable assembly
4. Select a Polymide or liner, carefully and slowly feed the liner in short forward movements down the cable assembly all the way through and out the torch neck end. Avoid kinking the liner, kinking the liner will ruin it and require replacement. Leave the liner extending out the end of the torch neck end by 3mm.
5. Fit the liner retaining nut together with the liner o-ring.
6. Replace the front end parts
7. Fit the liner collet, liner O-ring and liner retaining nut.
8. Push the liner firmly into the torch lead and tighten the liner retaining nut.
9. Install a U groove drive roller of the correct size to match the wire diameter being used.



(1) Remove mig torch front end parts

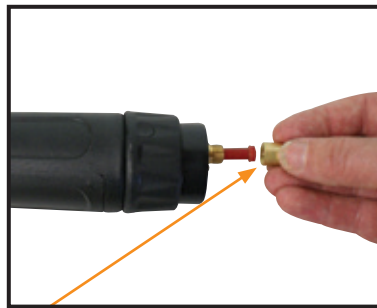

(2) Remove the liner retaining nut

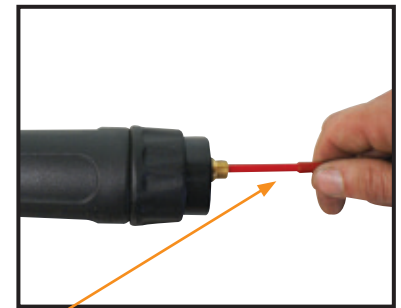

(3) Carefully pull out and completely remove the liner

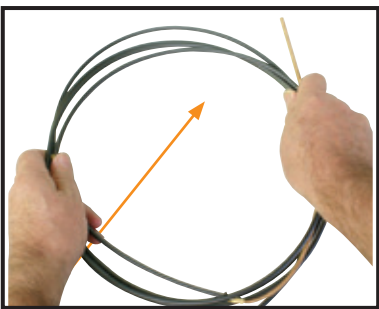

(4) Carefully unravel the new liner

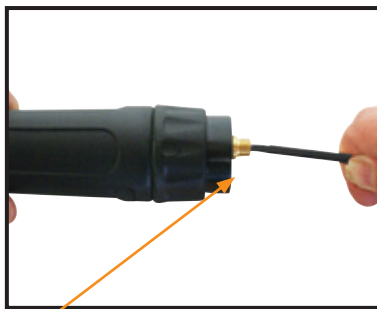

(5) Carefully feed in the new liner in short forward movements down the torch lead all the way to exit the torch neck. Be careful not to kink the liner

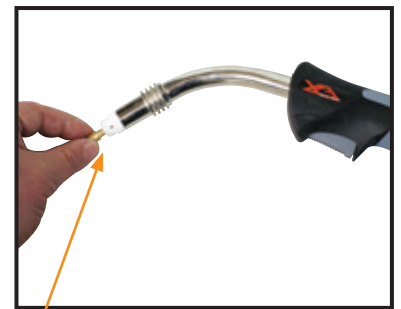

(6) Replace the front end parts

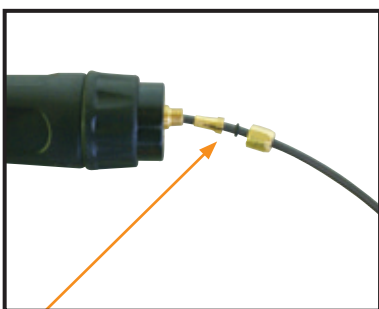

(7) Fit the liner collet, liner O-ring and liner retaining nut.

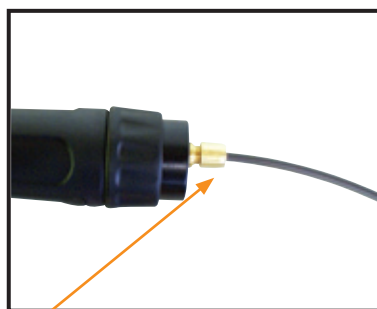

(8) Push the liner firmly into the torch lead and tighten the liner retaining nut

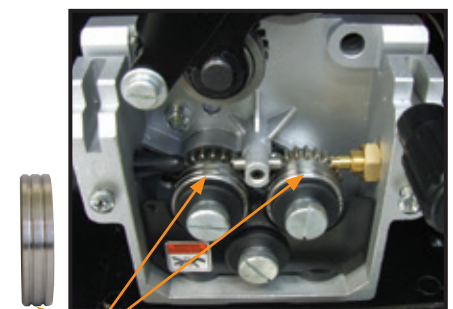

(9) Install a U groove drive roller of the correct size for the diameter wire being used.

Continued Torch & Wire Feed Set Up for Aluminium Wire

10. Remove the inlet guide tube from the front end machine euro connector using long nose pliers.
11. Carefully feed the extended Polymide liner section into the inlet guide tube hole of the machine euro connector
12. Feed the extended Polymide liner all the way up and over the drive roller
13. Tighten the torch euro connection to the machine euro connector
14. Cut the extended liner with a sharp Stanley knife just in front of the drive roller
15. Fit an Aluminium contact tip of the correct size to match the diameter of the wire being used
16. Fit the remaining front end parts to the torch neck ready for welding

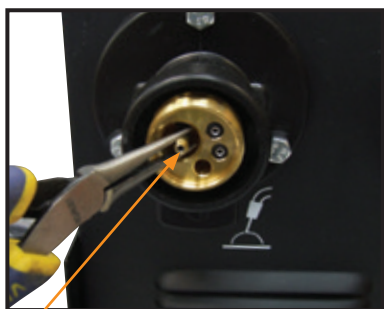

(10) Remove the inlet guide tube using long nose pliers.



(11) Carefully feed the Polymide liner into the inlet guide tube hole of the torch euro receptacle

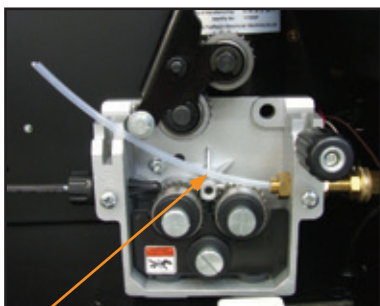

(12) Take the extended Polymide liner all the way up and over the drive roller



(13) Tighten and secure the torch euro connector to the machine euro receptacle

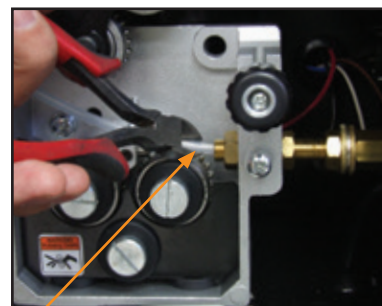

(14) Cut the extended Polymide liner with a sharp Stanley knife just in front of the drive roller

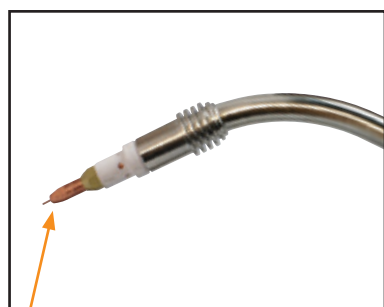

(15) Fit an Aluminium contact tip of the correct size to match the wire diameter being used

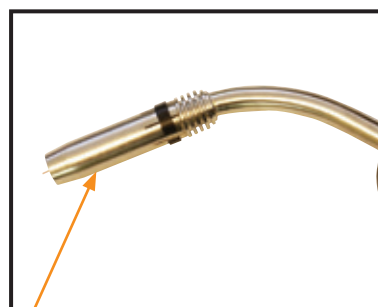

(16) Fit the remaining front end parts to the torch neck ready for welding.

MIG (Metal Inert Gas) Welding

Definition of MIG Welding - MIG (metal inert gas) welding also known as GMAW (gas metal arc welding) or MAG (metal active gas welding), is a semi-automatic or automatic arc welding process in which a continuous and consumable wire electrode and a shielding gas are fed through a welding gun. A constant voltage, direct current power source is most commonly used with MIG welding. There are four primary methods of metal transfer in MIG welding, called short circuit (also known as dip transfer) globular transfer, spray transfer and pulsed-spray, each of which has distinct properties and corresponding advantages and limitations. To perform MIG welding, the basic necessary equipment is a welding gun, a wire feed unit, a welding power supply, an electrode wire, and a shielding gas supply. Short circuit transfer is the most common used method whereby the wire electrode is fed continuously down the welding torch through to and exiting the contact tip. The wire touches the work piece and causes a short circuit the wire heats up and begins to form a molten bead, the bead separates from the end of the wire and forms a droplet that is transferred into the weld pool. This process is repeated about 100 times per second, making the arc appear constant to the human eye.

MIG Circuit Diagram

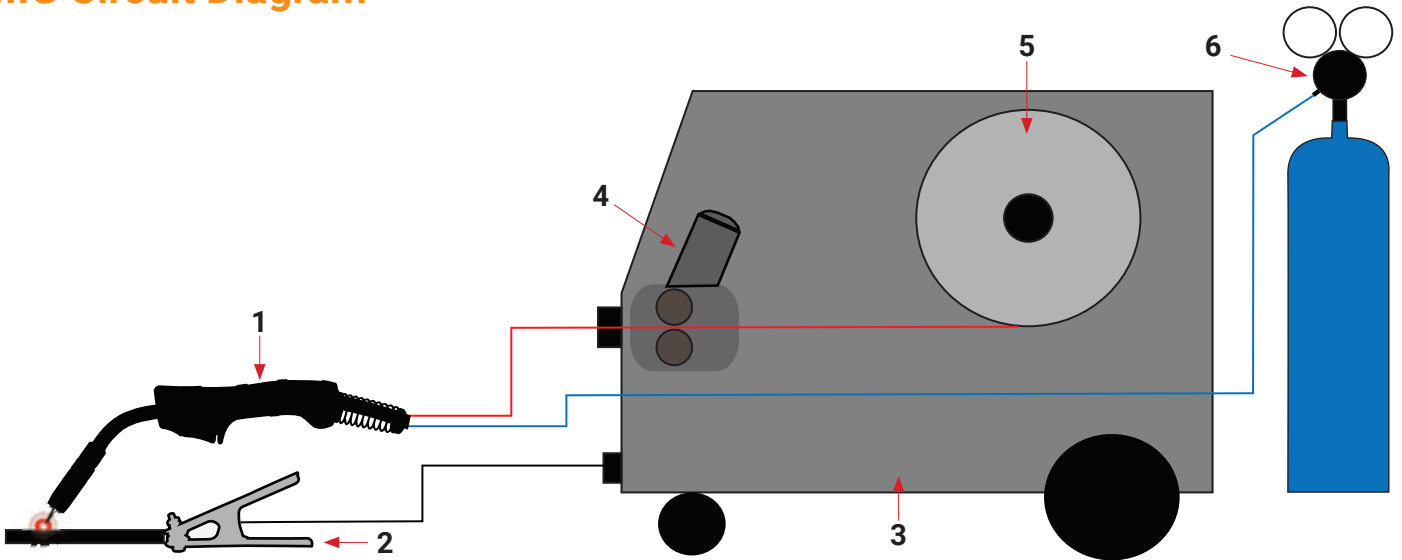

1. Mig Torch - 2. Work Piece - 3. Power Source - 4. Wire Feeder - 5. Wire Spool - 6. Gas

MIG (Metal Inert Gas) Welding

Short Circuit Transfer - Short circuit transfer is the most common used method whereby the wire electrode is fed continuously down the welding torch through to and exiting the contact tip. The wire touches the work piece and causes a short circuit the wire heats up and begins to form a molten bead, the bead separates from the end of the wire and forms a droplet that is transferred into the weld pool. This process is repeated about 100 times per second, making the arc appear constant to the human eye.

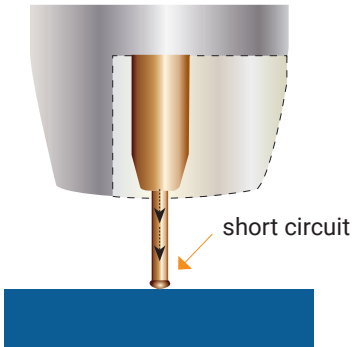

The wire approaches the work piece and touches the work creating a short circuit between the wire and the base metal, because there is no space between the wire and the base metal there is no arc and current flows through the wire.

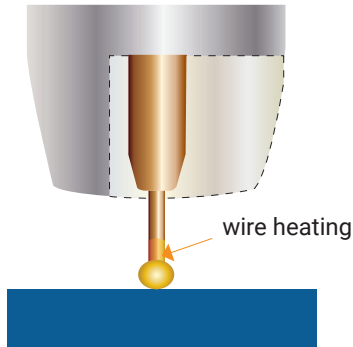

The wire cannot support all the current flow, resistance builds up and the wire becomes hot and weak and begins to melt

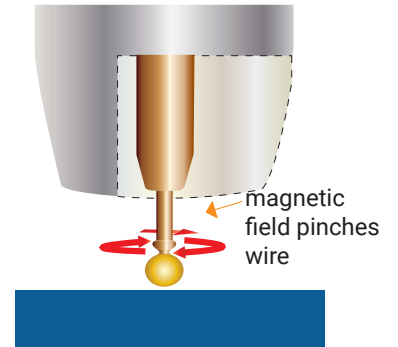

The current flow creates a magnetic field that begins to pinch the melting wire forming it into droplet

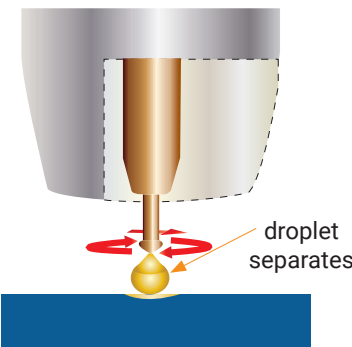

The pinch causes the forming droplet to separate and fall towards the now creating weld pool.

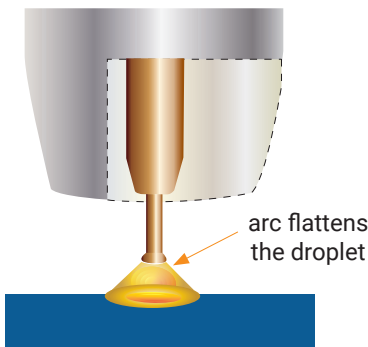

An arc is created at the separation of the droplet and the heat and force of the arc flattens out the droplet into the weld pool. The heat of the arc melts the end of the wire slightly as it feeds towards the base metal

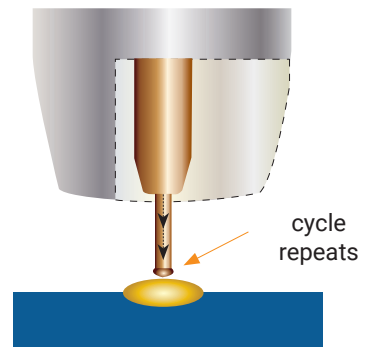

The wire feed speed overcomes the heat of the arc and the wire again approaches the work to short circuit and repeat the cycle.

Basic MIG Welding

Good weld quality and weld profile depends on gun angle, direction of travel, electrode extension (stick out), travel speed, thickness of base metal, wire feed speed (amperage) and arc voltage. To follow are some basic guides to assist with your setup.

Gun Position - Travel Direction, Work Angle

Gun position or technique usually refers to how the wire is directed at the base metal, the angle and travel direction chosen. Travel speed and work angle will determine the characteristic of the weld bead profile and degree of weld penetration.

Push Technique

The wire is located at the leading edge of the weld pool and pushed towards the un-melted work surface. This technique offers a better view of the weld joint and direction of the wire into the weld joint. Push technique directs the heat away from the weld puddle allowing faster travel speeds providing a flatter weld profile with light penetration - useful for welding thin materials. The welds are wider and flatter allowing for minimal clean up / grinding time.

Perpendicular Technique

The wire is fed directly into the weld, this technique is used primarily for automated situations or when conditions make it necessary. The weld profile is generally higher and a deeper penetration is achieved.

Drag Technique

The gun and wire is dragged away from the weld bead. The arc and heat is concentrated on the weld pool, the base metal receives more heat, deeper melting, more penetration and the weld profile is higher with more build up.

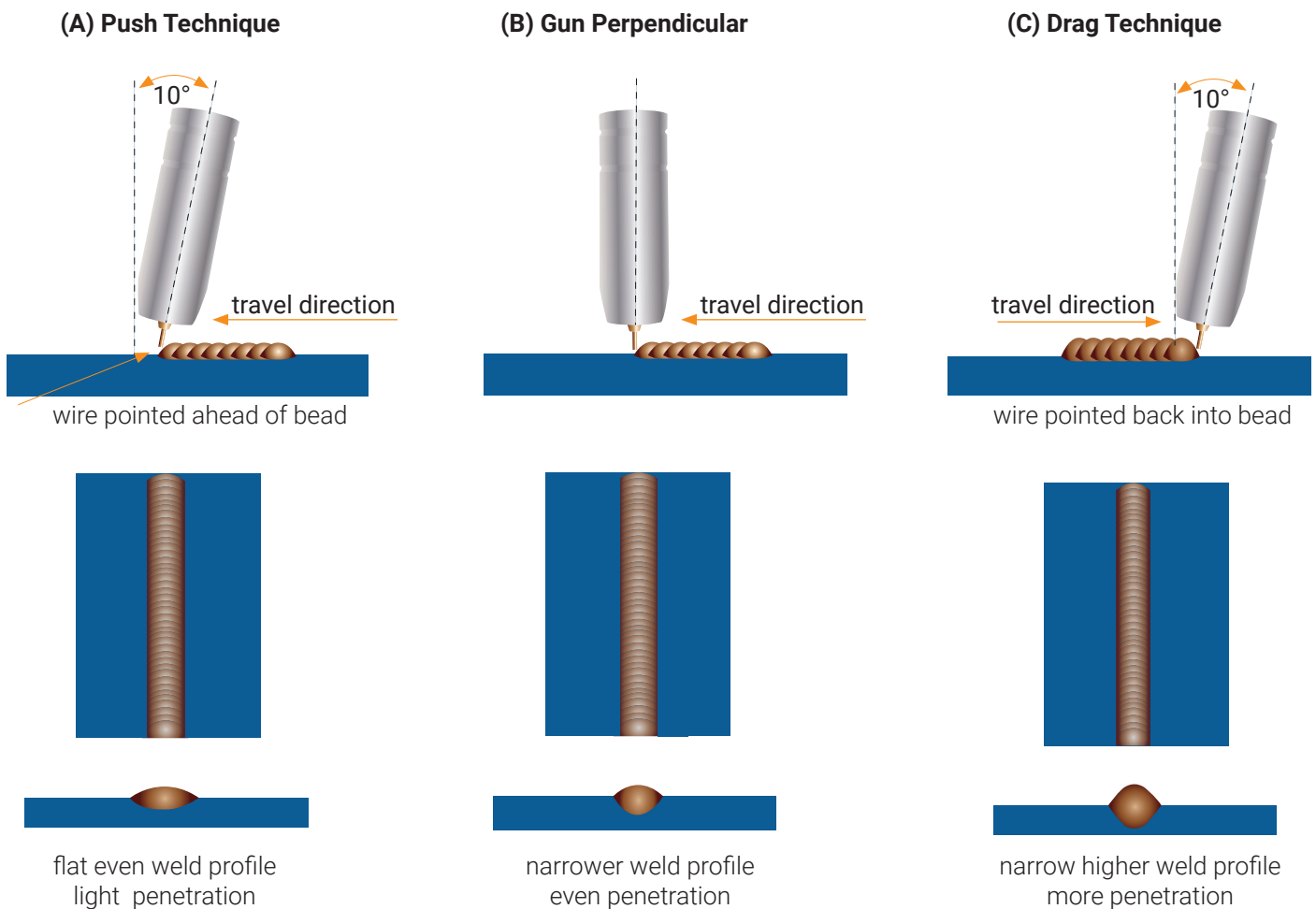

Travel Angle

Travel angle is the right to left angle relative to the direction of welding. A travel angle of 5° - 15° is ideal and produces a good level of control over the weld pool. A travel angle greater than 20° will give an unstable arc condition with poor weld metal transfer, less penetration, high levels of spatter, poor gas shield and poor quality finished weld.

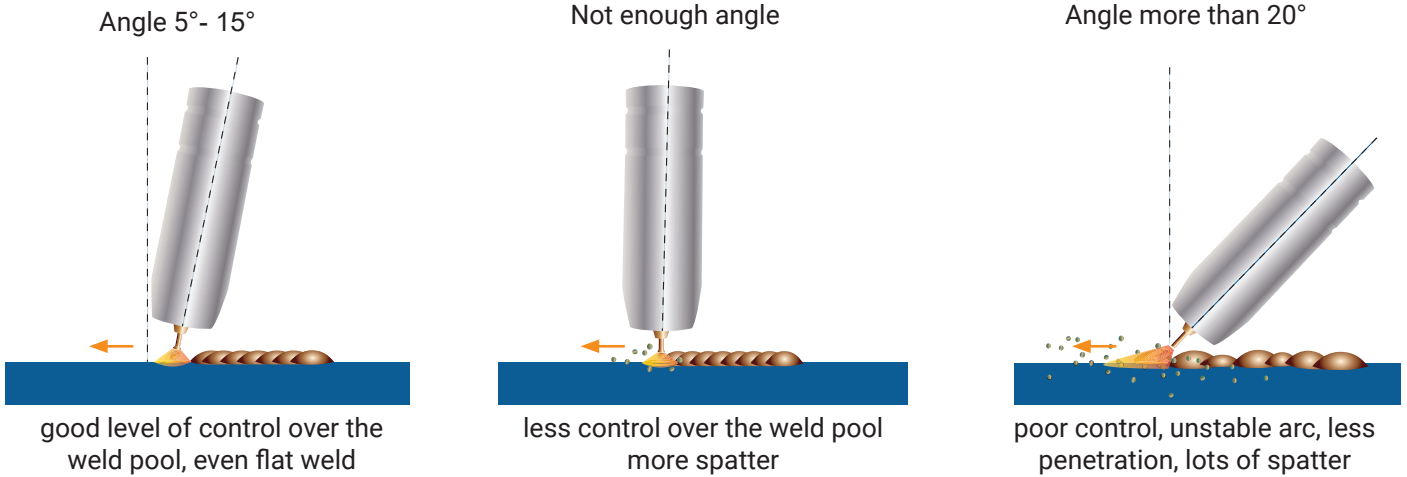

Angle to Work

The work angle is the forward back angle of the gun relative to the work piece.

The correct work angle provides good bead shape, prevents undercut, uneven penetration, poor gas shield and poor quality finished weld.

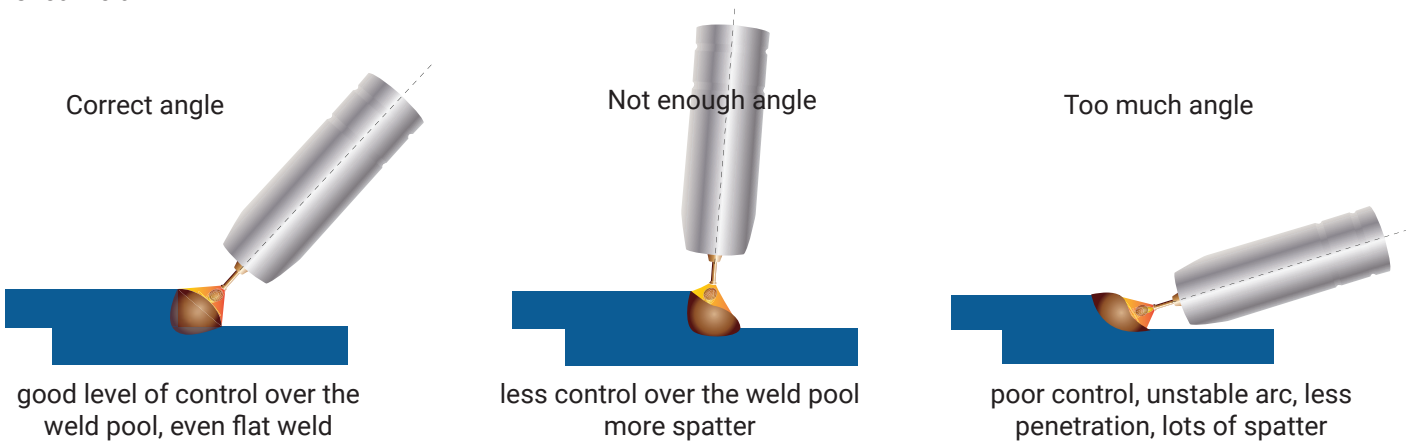

Stick Out

Stick out is the length of the unmelted wire protruding from the end of the contact tip.

A constant even stick out of 5-10mm will produce a stable arc, and an even current flow providing good penetration and even fusion. Too short stick out will cause an unstable weld pool, produce spatter and over heat the contact tip. Too long stick out will cause an unstable arc, lack of penetration, lack of fusion and increase spatter.

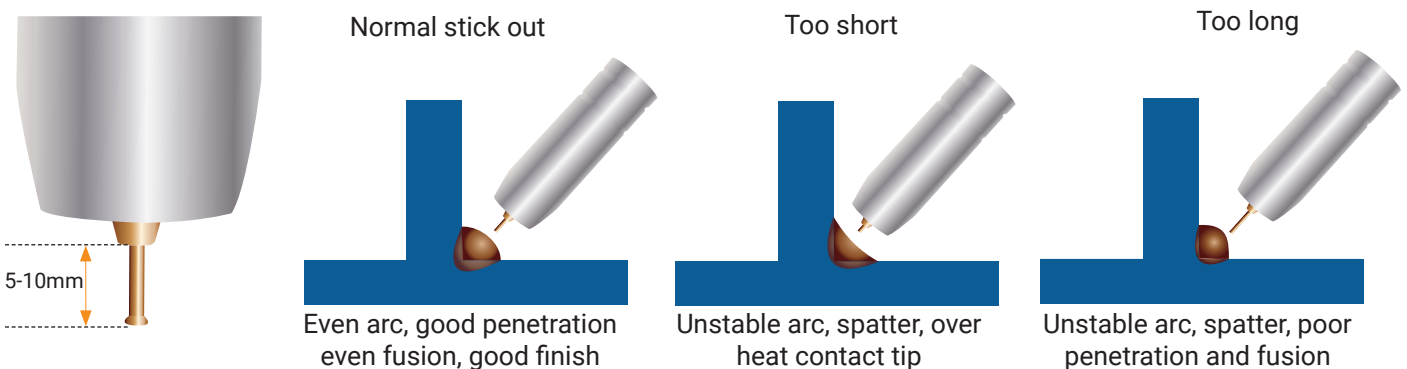

Travel Speed

Travel speed is the rate that the gun is moved along the weld joint and is usually measured in mm per minute. Travel speeds can vary depending on conditions and the welders skill and is limited to the welders ability to control the weld pool. Push technique allows faster travel speeds than Drag technique. Gas flow must also correspond with the travel speed, increasing with faster travel speed and decreasing with slower speed. Travel speed needs to match the amperage and will decrease as the material thickness and amperage increase.

Too Fast Travel Speed

A too fast travel speed produces too little heat per mm of travel resulting in less penetration and reduced weld fusion, the weld bead solidifies very quickly trapping gases inside the weld metal causing porosity. Undercutting of the base metal can also occur and an unfilled groove in the base metal is created when the travel speed is too fast to allow molten metal to flow into the weld crater created by the arc heat.

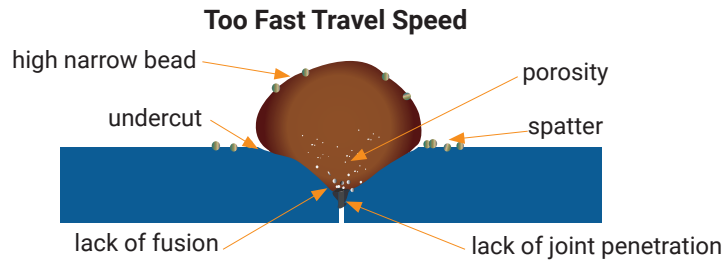

Too Slow Travel Speed

A too slow travel speed produces a large weld with lack of penetration and fusion. The energy from the arc dwells on top of the weld pool rather than penetrating the base metal. This produces a wider weld bead with more deposited weld metal per mm than is required resulting in a weld deposit of poor quality.

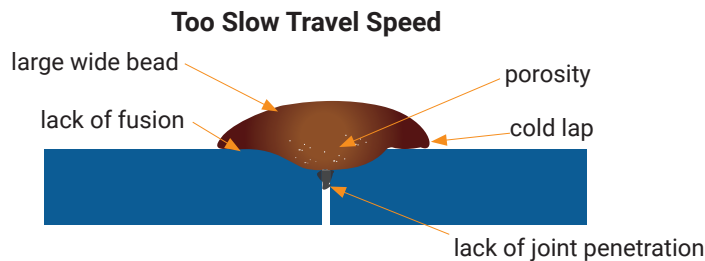

Correct Travel Speed

The correct travel speed keeps the arc at the leading edge of the weld pool allowing the base metal to melt sufficiently to create good penetration, fusion and wetting out of the weld pool producing a weld deposit of good quality.

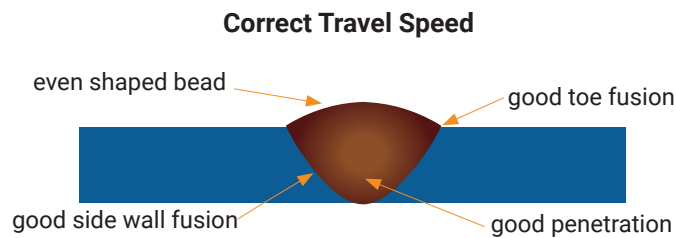

Wire types and sizes

Use the correct wire type for the base metal being welded. Use stainless steel wire for stainless steel, aluminium wires for aluminium and steel wires for steel.

Use a smaller diameter wire for thin base metals. For thicker materials use a larger wire diameter and larger machine, check the recommended welding capability of your machine.

As a guide refer to the "Welding Wire Thickness Chart" below.

WELDING WIRE DIAMETER CHART							
MATERIAL THICKNESS	RECOMMENDED WIRE DIAMETERS						
	MIG SOLID WIRE				GASLESS FLUX CORED WIRE		
	0.6mm	0.8mm	0.9mm	1.0mm	0.8mm	0.9mm	1.2mm
24 Gauge (.60mm)							
22 Gauge (.75mm)							
20 Gauge (.90mm)							
18 Gauge (1.0mm)							
16 Gauge (1.2mm)							
14 Gauge (1.9mm)							
3.0mm							
5.0mm							
6.0mm							
8.0mm							
10mm							
12.0mm							

For material thickness of 5.0mm and greater, multi-pass runs or a beveled joint design may be required depending on the amperage capability of your machine.

Gas selection

The purpose of the gas in the MIG process is to protect / shield the wire, the arc and the molten weld metal from the atmosphere. Most metals when heated to a molten state will react with the air in the atmosphere, without the protection of the shielding gas the weld produced would contain defects like porosity, lack of fusion and slag inclusions. Additionally some of the gas becomes ionised (electrically charged) and helps the current flow smoothly.

The correct gas flow is also very important in protecting the welding zone from the atmosphere.

Too low flow will give inadequate coverage and result in weld defects and unstable arc conditions.

Too high flow can cause air to be drawn into the gas column and contaminate the weld zone.

Use the correct shielding gas. Co₂ is good for steel and offers good penetration characteristics, the weld profile is narrower and slightly more raised than the weld profile obtained from Argon Co₂ mixed gas. Argon Co₂ mix gas offers better weld ability for thin metals and has a wider range of setting tolerance on the machine. Argon 80% Co₂ 20% is a good all round mix suitable for most applications.

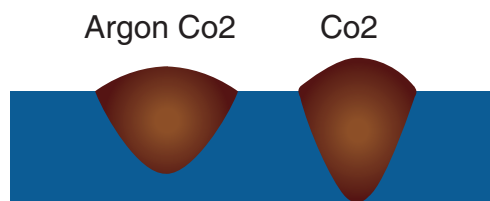

Penetration Pattern for Steel

Installation set up of the Spool Gun with UNI-MIG-MIG350MTS

1. Switch on the machine, select the **MIG** function with the Tig/MMA/Mig selector switch.
2. Select **Spool Gun** using the Standard/Spool Gun selector switch.
3. Connect the Spool Gun to the Euro Mig torch connection socket on the front panel, and tighten it. Connect the Spool Gun control cable to the receptacle and tighten it.
4. Insert the earth cable plug into the **Negative** socket on the front of the machine and tighten it.
5. Connect **Gas Line** to **Gas Regulator** and connect the gas regulator to the **Gas Cylinder**.
6. Connect the Weld power cable to the **Positive** socket.
7. Take the Spool Gun and push the **Cover Release Button** to unlock the wire feed / spool cover.
8. Place the **Wire Spool** onto the **Spool Holder** - Note: the spool retaining nut is Left Hand thread. Hold and snip the wire from the spool being sure to hold the wire to prevent rapid uncoiling.

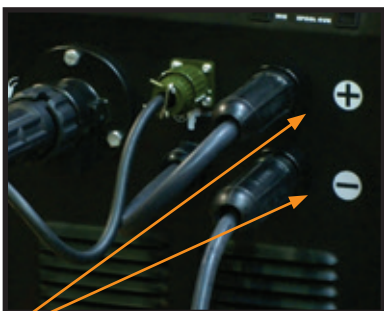

(6) Connect weld power lead to \oplus
Connect earth lead to \ominus

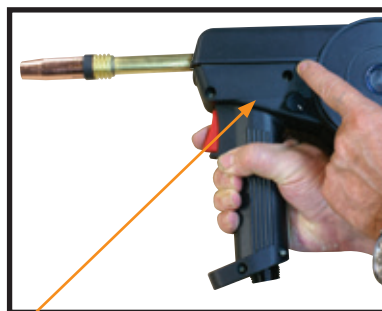

(7) Push the cover release button to unlock the wire feed / spool cover

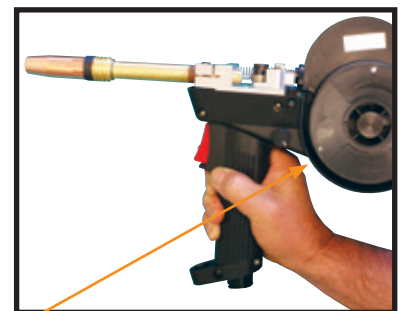

(8) Place a spool of wire onto the Spool holder. Note: the spool retaining nut is Left Hand thread, turn it clockwise to undo it

Continued set up of the Spool Gun with UNI-MIG-MIG350MTS

1. Carefully feed the wire over the drive roller into the outlet guide tube, feed through into the torch neck. Check that the drive roller being used complies with the wire diameter, replace the roller if necessary.
2. Align the wire into the groove of the drive roller and release the tension arm making sure the wire is in the groove of the drive roller.
3. Apply a medium amount of pressure to the drive roller by winding in the tension adjusting knob.
4. Remove the gas nozzle and contact tip from the torch neck, Pull the trigger to drive the wire through the neck until it exits the contact tip holder
5. Fit the correct sized contact tip and feed the wire through it, screw the contact tip into the tip holder of the torch neck and nip it up tightly.
6. Fit the gas nozzle to the torch head and close the wire spool cover
7. Carefully open the gas cylinder valve and set the flow rate to between 8-12 L/min.
8. Set the welding parameters using the wire feed and voltage control knobs.
9. Using the **Burn Back** control set the amount of wire to 'burn back' after you release the torch trigger. This prevents the wire becoming stuck in the weld pool when finishing the weld.

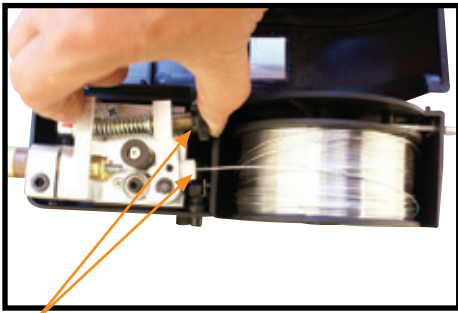

(9) Carefully feed the wire through the inlet guide tube onto the drive roller through into the outlet guide tube. Squeezing the tension arm adjustment knob to release the pressure of the tension arm will allow the wire to be guided through the drive roller easily

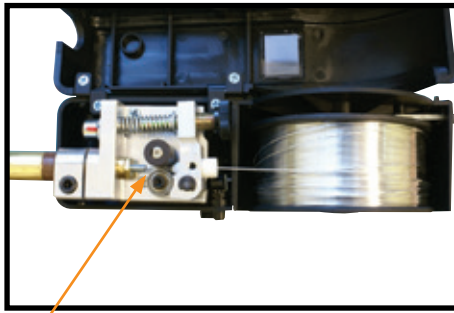

(10) Check to make sure that the wire passes cleanly through the drive roller into the outlet guide tube.

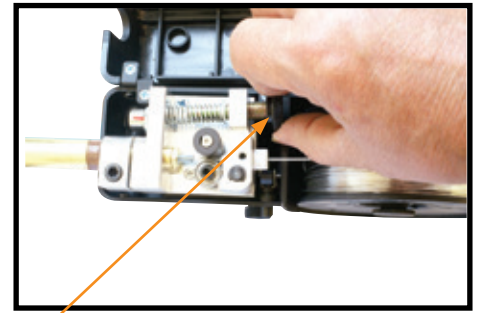

(11) Apply a medium amount of pressure using the tension arm adjustment knob.

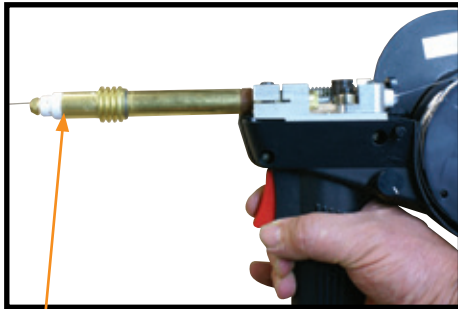

(12) Remove the gas nozzle and contact tip. Pull the trigger to drive the wire through the neck until it exits the contact tip holder

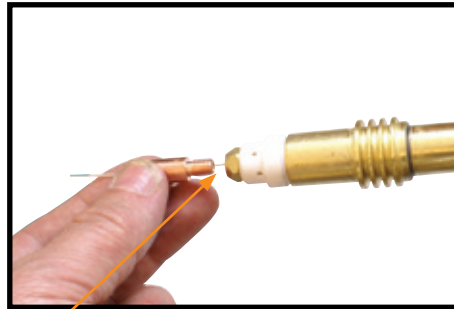

(13) Fit the contact tip over the wire and screw it into the tip holder, nip it up tight.



(14) Fit the gas nozzle and close the wire feed spool cover

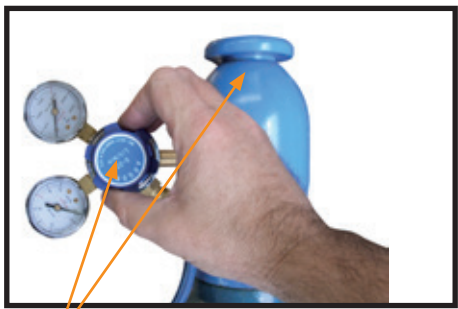

(15) Carefully open the valve of the gas cylinder, set the flow to 6-10 l/min



(16) Set welding parameters using the voltage and wire feed controls.



(17) Adjust the burn back control to prevent the wire sticking in the weld pool. Burn back control is located above the wire feed motor

Installation and set up for DC TIG welding with UNI-MIG-MIG350MTS

1. Switch on the machine, select the **TIG** function with the TIG/MMA/Mig selector switch.
2. Insert the power cable plug of the Tig torch into the **Negative** socket on the front of the machine and tighten it.
3. Insert the earth cable plug into the **Positive** socket on the front of the machine and tighten it.
4. Connect the gas line of the Tig torch to regulator and connect the regulator to the gas cylinder.



(4) Connect the gas line to the regulator and connect to the gas cylinder

(1) Set TIG/MMA/Mig selector switch to TIG

(3) Connect earth lead to ⊕

(2) Connect the TIG torch cable connector to ⊖

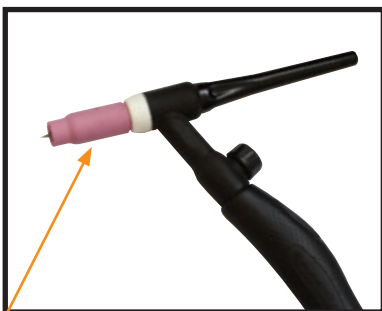

(5) Assemble front end parts of the TIG torch

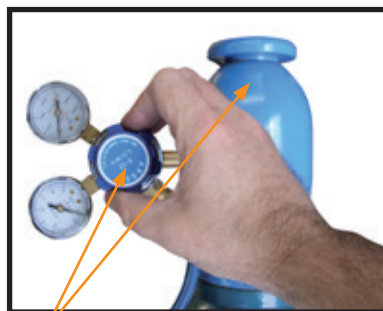

(6) Carefully open the valve of the gas cylinder, set the flow to 6-10 l/min



(7) Set the welding current using the amperage control dial

LIFT ARC DC TIG Operation

5. Make sure the front end parts of the tig torch are correctly assembled, use the correct size and type of tungsten electrode for the job, the tungsten electrode requires a sharpened point for DC welding.
6. Turn on the Gas Valve located on the tig torch handle.
7. Lay the outside edge of the Gas Cup on the work piece with the Tungsten Electrode 1- 2mm from the work piece.
8. With a small movement rotate the Gas Cup forward so that the Tungsten Electrode touches the work piece.
9. Now rotate the Gas Cup in the reverse direction to lift the Tungsten electrode from the work piece to create the arc.

Lift Arc ignition allows the arc to be started easily in DC Tig by simply touching the tungsten to the work piece and lifting it up to start the arc. This prevents the tungsten tip sticking to the work piece and breaking the tip from the tungsten electrode. There is a particular technique called "rocking the cup" used in the Lift Arc process that provides easy use of the Lift Arc function.



(5) Assemble front end parts of the TIG torch, fitting a sharpened tungsten suitable for DC welding.

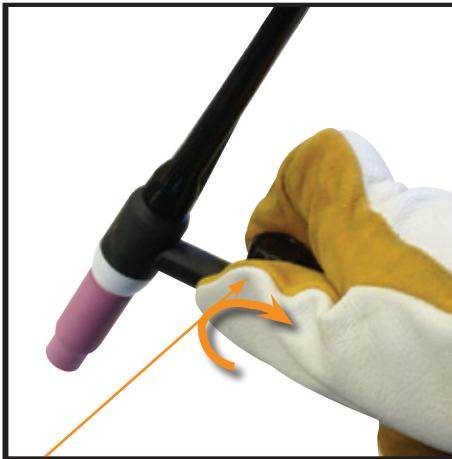

(6) Turn on the Gas Valve

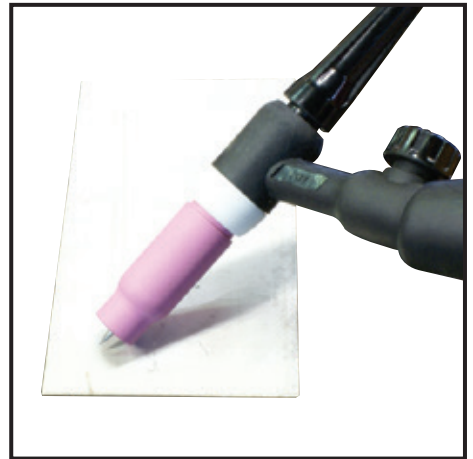

(7) Lay the outside edge of the Gas Cup on the work piece with the Tungsten Electrode 1- 2mm from the work piece.

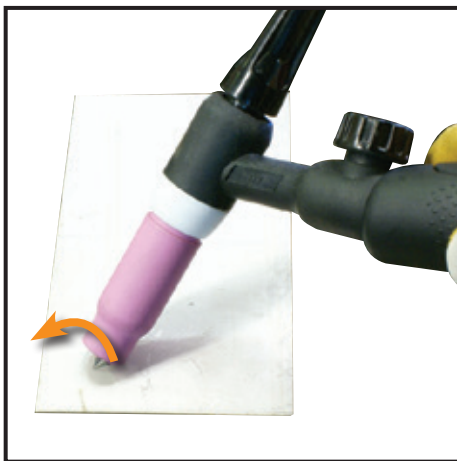

(8) With a small movement rotate the Gas Cup forward so that the Tungsten Electrode touches the work piece.

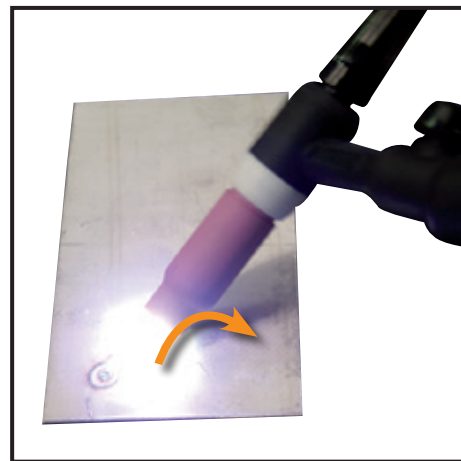

(9) Now rotate the Gas Cup in the reverse direction to lift the Tungsten electrode from the work piece to create the arc.

IMPORTANT! - We strongly recommend that you check for gas leakage prior to operation of your machine. We recommend that you close the cylinder valve when the machine is not in use.

Welding Guns Of Australia PTY LTD, authorised representatives or agents of Welding Guns Of Australia PTY LTD will not be liable or responsible for the loss of any gas.

DC TIG Welding

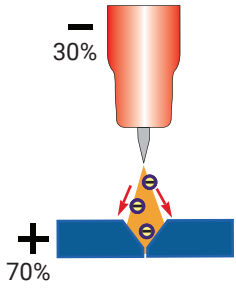

The DC power source uses what is known as DC (direct current) in which the main electrical component known as electrons flow in only one direction from the negative pole (terminal) to the positive pole (terminal). In the DC electrical circuit there is an electrical principle at work which should always be taken into account when using any DC circuit. With a DC circuit 70% of the energy (heat) is always on the positive side. This needs to be understood because it determines what terminal the TIG torch will be connected to (this rule applies to all the other forms of DC welding as well).

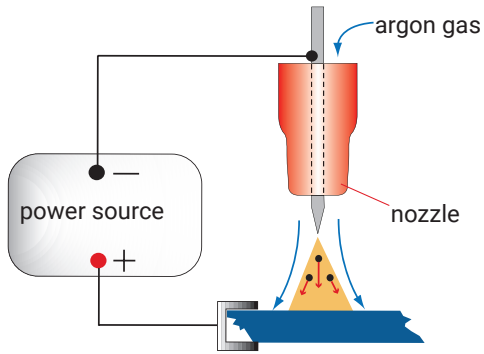

DC TIG welding is a process in which an arc is struck between a TUNGSTEN electrode and the metal work piece. The weld area is shielded by an inert gas flow to prevent contamination of the tungsten, molten pool and weld area.

When the TIG arc is struck the inert gas is ionized and superheated changing its molecular structure which converts it into a plasma stream. This plasma stream flowing between the tungsten and the work piece is the TIG arc and can be as hot as 19,000°C. It is a very pure and concentrated arc which provides the controlled melting of most metals into a weld pool. TIG welding offers the user the greatest amount of flexibility to weld the widest range of material and thickness and types. DC TIG welding is also the cleanest weld with no sparks or spatter.

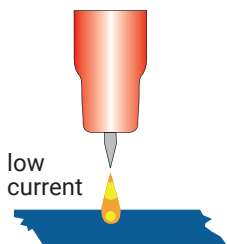

The intensity of the arc is proportional to the current that flows from the tungsten. The welder regulates the welding current to adjust the power of the arc. Typically thin material requires a less powerful arc with less heat to melt the material so less current (amps) is required, thicker material requires a more powerful arc with more heat so more current (amps) are necessary to melt the material.

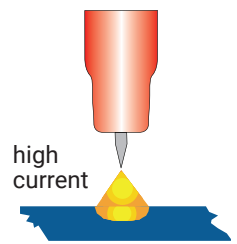

LIFT ARC IGNITION for TIG (tungsten inert gas) Welding

Lift Arc is a form of arc ignition where the machine has low voltage on the electrode to only a few volts, with a current limit of one or two amps (well below the limit that causes metal to transfer and contamination of the weld or electrode). When the machine detects that the tungsten has left the surface and a spark is present, it immediately (within microseconds) increases power, converting the spark to a full arc. It is a simple, safe lower cost alternative arc ignition process to HF (high frequency) and a superior arc start process to scratch start.

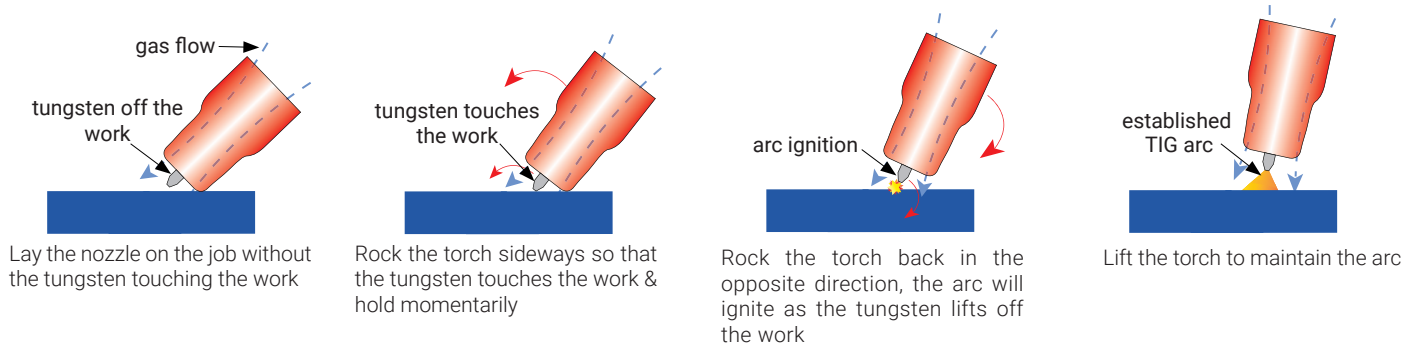

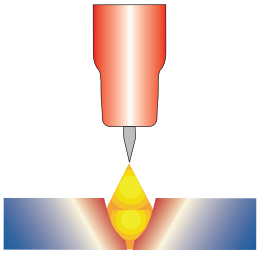

TIG Welding Fusion Technique

Manual TIG welding is often considered the most difficult of all the welding processes. Because the welder must maintain a short arc length, great care and skill are required to prevent contact between the electrode and the workpiece. Similar to Oxygen Acetylene torch welding, Tig welding normally requires two hands and in most instances requires the welder to manually feed a filler wire into the weld pool with one hand while manipulating the welding torch in the other. However, some welds combining thin materials can be accomplished without filler metal like edge, corner, and butt joints. This is known as Fusion welding where the edges of the metal pieces are melted together using only the heat and arc force generated by the TIG arc. Once the arc is started the torch tungsten is held in place until a weld pool is created, a circular movement of the tungsten will assist in creating a weld pool of the desired size. Once the weld pool is established tilt the torch at about a 75° angle and move smoothly and evenly along the joint while fusing the materials together.

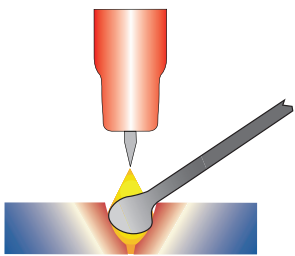
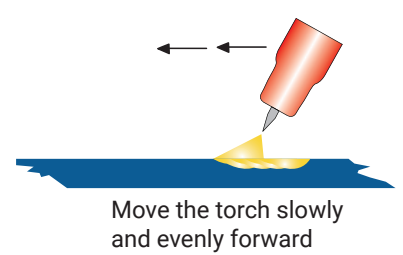
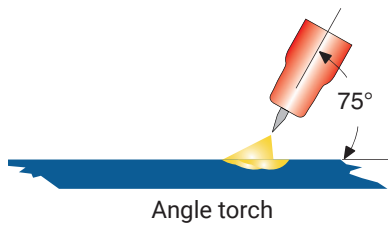
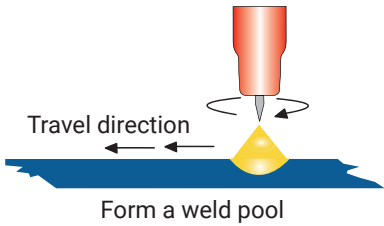

TIG Welding with Filler Wire Technique

It is necessary in many situations with TIG welding to add a filler wire into the weld pool to build up weld reinforcement and create a strong weld. Once the arc is started the torch tungsten is held in place until a weld pool is created, a circular movement of the tungsten will assist in creating a weld pool of the desired size. Once the weld pool is established tilt the torch at about a 75° angle and move smoothly and evenly along the joint. The filler metal is introduced to the leading edge of the weld pool. The filler wire is usually held at about a 15° angle and fed into the leading edge of the molten pool, the arc will melt the filler wire into the weld pool as the torch is moved forward. Also a dabbing technique can be used to control the amount of filler wire added, the wire is fed into the molten pool and retracted in a repeating sequence as the torch is moved slowly and evenly forward. It is important during the welding to keep the molten end of the filler wire inside the gas shield as this protects the end of the wire from being oxidised and contaminating the weld pool.

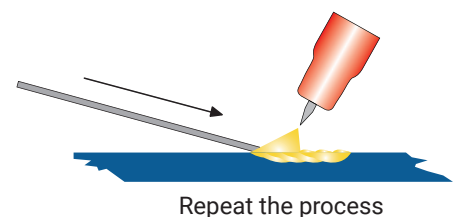
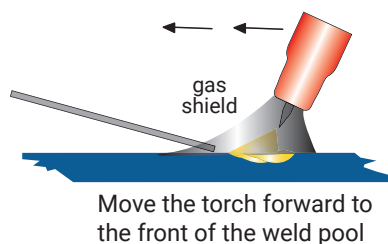
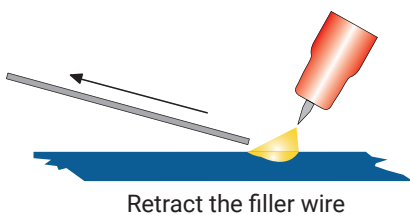
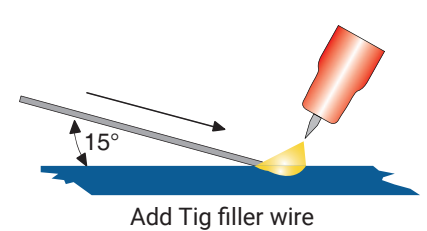
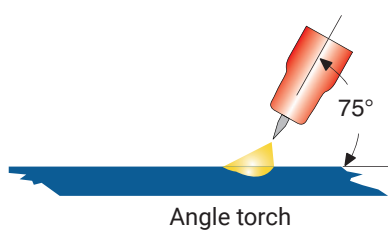
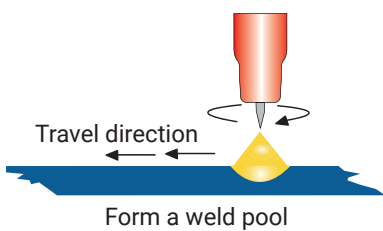

Tungsten Electrodes

Tungsten is a rare metallic element used for manufacturing TIG welding electrodes. The TIG process relies on tungsten's hardness and high-temperature resistance to carry the welding current to the arc. Tungsten has the highest melting point of any metal, 3,410 degrees Celsius.

Tungsten electrodes are nonconsumable and come in a variety of sizes, they are made from pure tungsten or an alloy of tungsten and other rare earth elements. Choosing the correct tungsten depends on the material being welded, the amount of amps required and whether you are using AC or DC welding current.

Tungsten electrodes are colour-coded at the end for easy identification.

Below are the most commonly used tungsten electrodes found in the New Zealand and Australian market.

Thoriated

Thoriated tungsten electrodes (AWS classification EWTh-2) contain a minimum of 97.30 percent tungsten and 1.70 to 2.20 percent thorium and are called 2 percent thoriated. They are the most commonly used electrodes today and are preferred for their longevity and ease of use. Thorium increases the electron emission qualities of the electrode, which improves arc starts and allows for a higher current-carrying capacity. This electrode operates far below its melting temperature, which results in a considerably lower rate of consumption and eliminates arc wandering for greater stability. Compared with other electrodes, thoriated electrodes deposit less tungsten into the weld puddle, so they cause less weld contamination. Thorium however is a low-level radioactive hazard and many users have switched to other alternatives. Regarding the radioactivity, thorium is an alpha emitter but when it is enclosed in a tungsten matrix the risks are negligible. Thus holding a stick of Thoriated tungsten in your hand should not pose a great threat unless a welder has open cuts on their skin. Thoriated tungsten should not get in contact with open cuts or wounds. The more significant danger to welders can occur when thorium oxide gets into the lungs. This can happen from the exposure to vapours during welding or from ingestion of material/dust in the grinding of the tungsten. Follow the manufacturer's warnings, instructions, and the Material Safety Data Sheet (MSDS) for its use.

Ceriated (Color Code: Orange)

Ceriated tungsten electrodes (AWS classification EWCe-2) contain a minimum of 97.30 percent tungsten and 1.80 to 2.20 percent cerium and are referred to as 2 percent ceriated. Ceriated tungstens perform best in DC welding at low current settings. They have excellent arc starts at low amperages and become popular in such applications as orbital tube welding, thin sheet metal work. They are best used to weld carbon steel, stainless steel, nickel alloys, and titanium, and in some cases it can replace 2 percent thoriated electrodes. Ceriated tungsten is best suited for lower amperages it should last longer than Thoriated tungsten higher amperage applications are best left to Thoriated or Lanthanated tungsten.

Lanthanated (Color Code: Gold)

Lanthanated tungsten electrodes (AWS classification EWLa-1.5) contain a minimum of 97.80 percent tungsten and 1.30 percent to 1.70 percent lanthanum, and are known as 1.5 percent lanthanated. These electrodes have excellent arc starting, a low burn off rate, good arc stability, and excellent re-ignition characteristics. Lanthanated tungstens also share the conductivity characteristics of 2 percent thoriated tungsten. Lanthanated tungsten electrodes are ideal if you want to optimise your welding capabilities. They work well on AC or DC electrode negative with a pointed end, or they can be balled for use with AC sine wave power sources. Lanthanated tungsten maintains a sharpened point well, which is an advantage for welding steel and stainless steel on DC or AC from square wave power sources.

Zirconiated (Color Code: White)

Zirconiated tungsten electrodes (AWS classification EWZr-1) contain a minimum of 99.10 percent tungsten and 0.15 to 0.40 percent zirconium. Most commonly used for AC welding Zirconiated tungsten produces a very stable arc and is resistant to tungsten spitting. It is ideal for AC welding because it retains a balled tip and has a high resistance to contamination. Its current-carrying capacity is equal to or greater than that of thoriated tungsten. Zirconiated tungsten is not recommended for DC welding.

Tungsten Electrodes Rating for Welding Currents

Tungsten Diameter mm	DC Current Amps Torch Negative 2% Thoriated	AC Current Amps Un-Balanced Wave 0.8% Zirconiated	AC Current Amps Balanced Wave 0.8% Zirconiated
1.0mm	15 - 80	15 - 80	20 - 60
1.6mm	70 - 150	70 - 150	60 - 120
2.4mm	150 - 250	140 - 235	100 - 180
3.2mm	250 - 400	225 - 325	160 - 250
4.0mm	400 - 500	300 - 400	200 - 320

Tungsten Preparation

Always use **DIAMOND** wheels when grinding and cutting. While tungsten is a very hard material, the surface of a diamond wheel is harder, and this makes for smooth grinding. Grinding without diamond wheels, such as aluminium oxide wheels, can lead to jagged edges, imperfections, or poor surface finishes not visible to the eye that will contribute to weld inconsistency and weld defects.

Always ensure to grind the tungsten in a longitudinal direction on the grinding wheel. Tungsten electrodes are manufactured with the molecular structure of the grain running lengthwise and thus grinding crosswise is "grinding against the grain." If electrodes are ground crosswise, the electrons have to jump across the grinding marks and the arc can start before the tip and wander. Grinding longitudinally with the grain, the electrons flow steadily and easily to the end of the tungsten tip. The arc starts straight and remains narrow, concentrated, and stable.

grind longitudinal on the grinding wheel

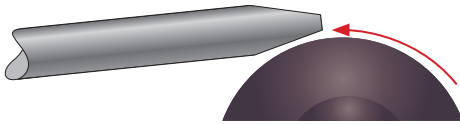

don't grind across the grinding wheel

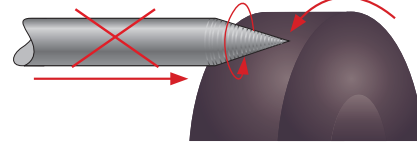

Electrode Tip/Flat

The shape of the tungsten electrode tip is an important process variable in precision arc welding. A good selection of tip/flat size will balance the need for several advantages. The bigger the flat, the more likely arc wander will occur and the more difficult it will be to arc start. However, increasing the flat to the maximum level that still allows arc start and eliminates arc wander will improve the weld penetration and increase the electrode life. Some welders still grind electrodes to a sharp point, which makes arc starting easier. However, they risk decreased welding performance from melting at the tip and the possibility of the point falling off into the weld pool.

2.5 times tungsten diameter

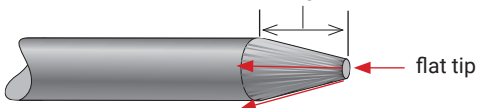

Electrode Included Angle/Taper - DC Welding

Tungsten electrodes for DC welding should be ground longitudinally and concentrically with diamond wheels to a specific included angle in conjunction with the tip/flat preparation. Different angles produce different arc shapes and offer different weld penetration capabilities. In general, blunter electrodes that have a larger included angle provide the following benefits:

- Last Longer
- Have better weld penetration
- Have a narrower arc shape
- Can handle more amperage without eroding.

Sharper electrodes with smaller included angle provide:

- Offer less arc weld
- Have a wider arc
- Have a more consistent arc

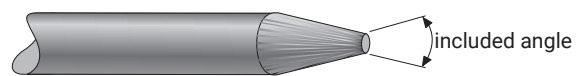
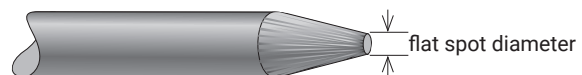

The included angle determines weld bead shape and size. Generally, as the included angle increases, penetration increases and bead width decreases.

Tungsten Diameter	Diameter at the Tip - mm	Constant Included Angle - Degrees	Current Range Amps	Current Range Pulsed Amps
1.0mm	.250	20	05 - 30	05 - 60
1.6mm	.500	25	08 - 50	05 - 100
1.6mm	.800	30	10 - 70	10 - 140
2.4mm	.800	35	12 - 90	12 - 180
2.4mm	1.100	45	15 - 150	15 - 250
3.2mm	1.100	60	20 - 200	20 - 300
3.2mm	1.500	90	25 - 250	25 - 350

SB36 MIG TORCH

Suregrip Series

300A AIR COOLED MIG WELDING TORCH

Rating: 300A CO₂ 270A mixed gas EN60974-7 @ 60% duty cycle. 0.8 to 1.2mm wires

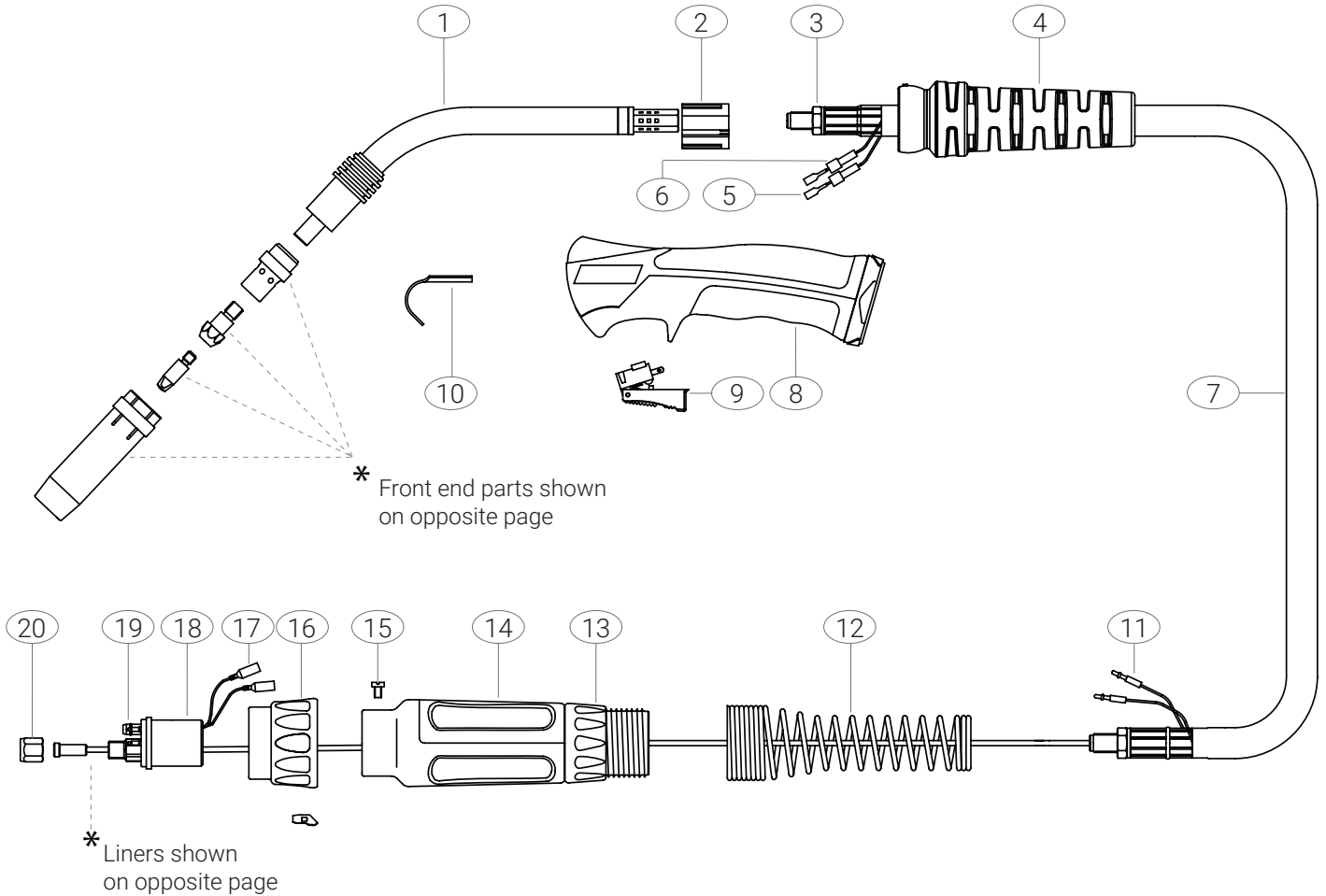

Torch Model			
Description	Part Number	4 Mt	5 Mt
SB36 Suregrip Ergo Torch Package	SB36-3	SB36-4	SB36-5

Spare Parts

Part Number	Description
1	SNK36 Swan Neck
8	BZLH Ergo handle complete with Trigger
9	BX0020 Trigger



©All rights reserved. No part of this publication may be reproduced, stored in a retrieval system or transmitted by any means ,electronic, mechanical, photocopying or otherwise without the prior permission of ©Uniarco the copyright holder.

These parts are manufactured in China and are offered as replacement parts suitable for "BINZEL" style torches.

SB36 MIG TORCH

Suregrip Series

Front end consumables

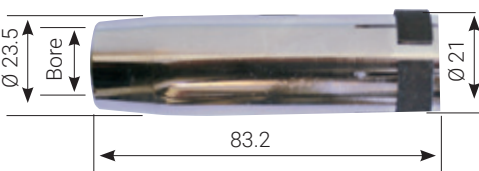
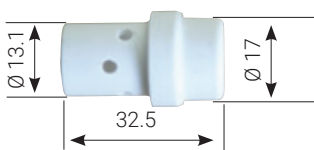
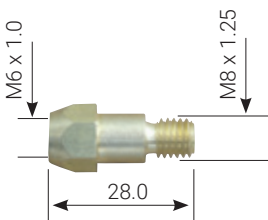
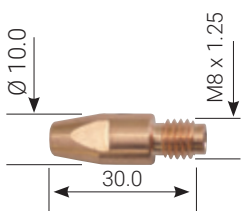
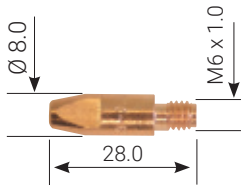

SB36 Contact Tips M6

Part Number	Description
PCT0009-06	Contact Tip Steel (0.6mm)
PCT0009-08	Contact Tip Steel (0.8mm)
PCT0009-09	Contact Tip Steel (0.9mm)
PCT0009-10	Contact Tip Steel (1.0mm)
PCT0009-12	Contact Tip Steel (1.2mm)
PCT0009-16	Contact Tip Steel (1.6mm)
PCTZR009-09	Contact Tip Steel Long Life (0.9mm)
PCTZR009-12	Contact Tip Steel Long Life (1.2mm)
PCTAL0009-09	Contact Tip Aluminium (0.9mm)
PCTAL0009-10	Contact Tip Aluminium (1.0mm)
PCTAL0009-12	Contact Tip Aluminium (1.2mm)
PCT0005-08	Contact Tip Steel M8 (0.8mm)
PCT0005-09	Contact Tip Steel M8 (0.9mm)
PCT0005-10	Contact Tip Steel M8 (1.0mm)
PCT0005-12	Contact Tip Steel M8 (1.2mm)
PCT0005-16	Contact Tip Steel M8 (1.6mm)
PCTAL0005-08	Contact Tip Aluminium M8 (0.8mm)
PCTAL0005-09	Contact Tip Aluminium M8 (0.9mm)
PCTAL0005-10	Contact Tip Aluminium M8 (1.0mm)
PCTAL0005-12	Contact Tip Aluminium M8 (1.2mm)
PCTAL0005-16	Contact Tip Aluminium M8 (1.6mm)

SB36 Tip Holder M8

Part Number	Description
PCTH36M6S	Contact Tip Holder M6 (Short)
PCTH36M8S	Contact Tip Holder M8 (Short)

SB36 Tip Holder M6

Part Number	Description
PCTH36M6L	Contact Tip Holder M6 (Long)
PCTH36M8L	Contact Tip Holder M8 (Long)

SB36 Gas Diffuser

Part Number	Description
PCGD36	Gas Diffuser

SB36 Gas Nozzle

Part Number	Description
PGN36CYL	Cylindrical Nozzle
PGN36CON	Conical Nozzle
PGN36TAP	Tapered Nozzle

SB36 Liners

Part Number	Description
SLR3M	Red Steel Liner 3 Metre
SLR4M	Red Steel Liner 4 Metre
SLR5M	Red Steel Liner 5 Metre
SLY3M	Yellow Steel Liner 3 Metre
SLY4M	Yellow Steel Liner 4 Metre
SLY5M	Yellow Steel Liner 5 Metre
TLR3M	Red Aluminium Liner 3 Metre
TLR4M	Red Aluminium Liner 4 Metre
TLY3M	Yellow Aluminium Liner 3 Metre
TLY4M	Yellow Aluminium Liner 4 Metre
NKSTL	Neck Spring for Aluminium

Liners

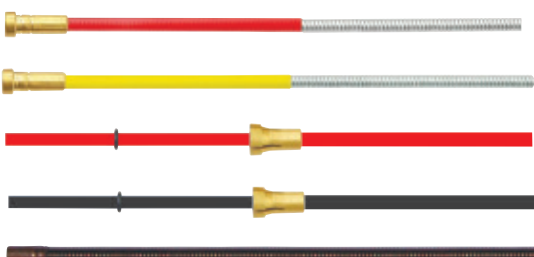

240A Air-Cooled MIG Welding Torch

Rating: 240A CO2 220A mixed gas, EN60974-7 @ 60% duty cycle. 0.8 to 1.2mm wires

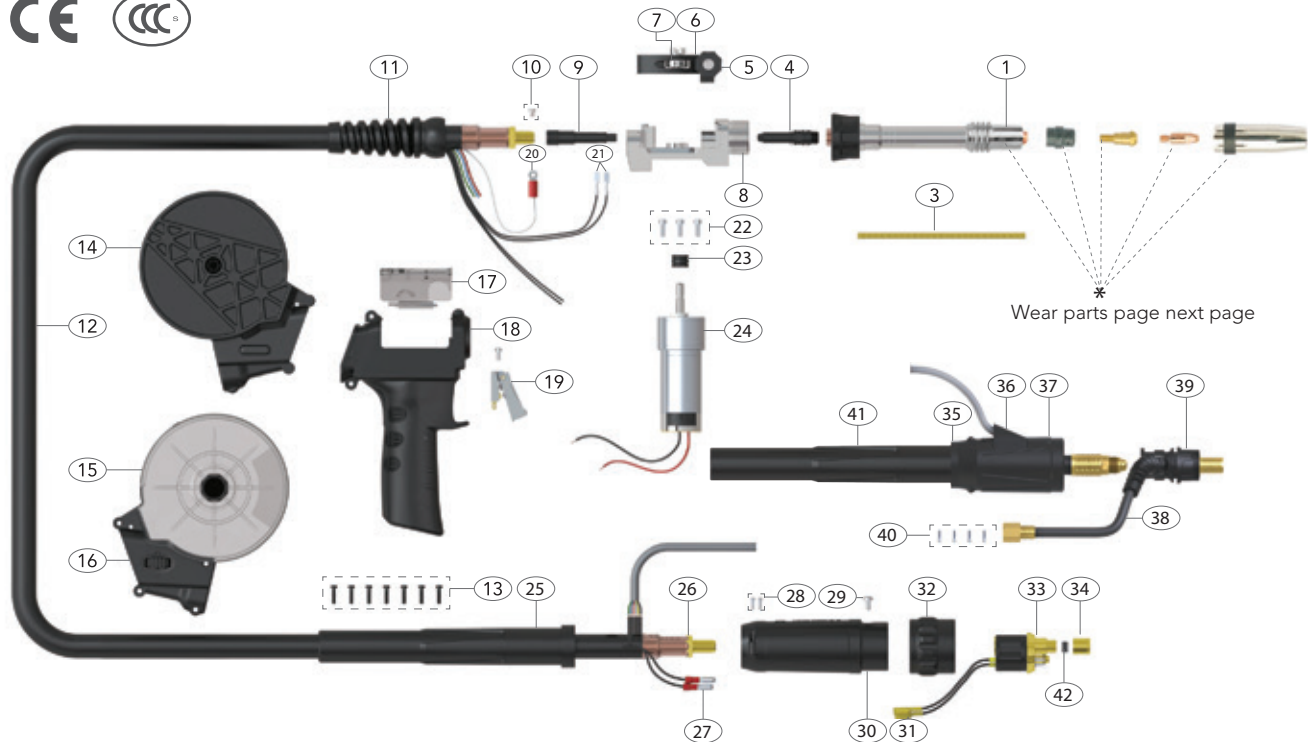

Torch Model	Description	Part Number
240 Spool Gun Suregrip series		6Mt
		PLSP240A-24

Spare Parts			
Part Number	Description	Part Number	Description
1	USP2401	23	UGP7020W-08U Driver Roll For Aluminium Wire 0.8
3	USP1502		UGP7020W-09U Driver Roll For Aluminium Wire 0.9
4	UGP36006		UGP7020W-10U Driver Roll For Aluminium Wire 1.0
5	UGP36402B		UGP7020W-12U Driver Roll For Aluminium Wire 1.2
6	UGP36402	24	UGP7020-24 Motor 24V DC
7	UGP36402R		UGP7020-42 Motor 42V DC
8	USP36001	25	UPA2041 Cable Support
9	USP36006	26	UB1505 Lock Nut
10	SC2563	27	UB1522 Cable Terminal Male
11	MIG8015	28	SCSP1-1 Gun Plug Housing Screw
12	PLSP1517-60ER	29	UBL1541 Gun Plug Screw
	PLSP1517-60DN	30	SC2578H/L Gun Plug Housing Assembly
13	UKA3X20	31	UB1523 Gun Plug Terminal Female
14	USP2515SP-B	32	UC1519/S Housing Nut
15	USP2515SP-C	33	UC1528 Hybrid Gun Plug Body C/W Spring Pins
16	USP2515SP-PT-1K	34	UB1525 Liner Nut
	USP2515SP-PT-5K	35	USLH26-SM Cable Support Large
	USP2515SP-PT-10K	36	USLH26-C Surelok™ Housing Cover
	USP2515SP-PT-25K	37	USLH26-H Surelok™ Housing Large
17	UGP2514-C	38	USL-1 Gas Supply Hose
18	CSP2515-KJ	39	USL3550 Surelok™ Body & Support
19	UGP2516	40	UERSP1 Screw Pack
20	SC2597	41	UPA3541 Cable Support
21	UB1521	42	UB1525W Washer
22	UGPMS1		
23	UGP7020W-09		
	UGP7020W-10		

*Note: Gas supply hoses are specified by utilizing the part number and a termination suffix from the gas supply hose table on page 8.
 Example: USL-1-GS1
 Gas supply hoses C/W 3/8" BSP fitting.
 Denotes torch package drive roll set up
 Note: All packages supplied with hard and soft wire drive roll

240AMP SPOOL GUN

UNIMIG

Suregrip Series



Front end consumables

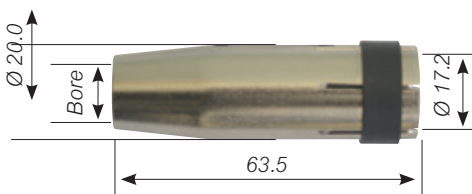
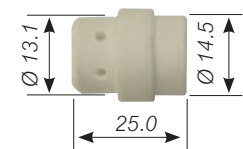
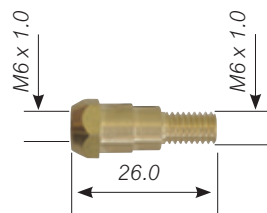
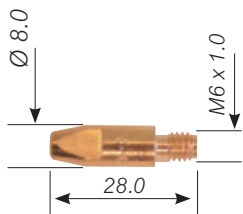

SB24 Contact Tips

Part Number	Description	QTY
PCT0009-06	Contact Tip Steel (0.6mm)	QTY10
PCT0009-08	Contact Tip Steel (0.8mm)	QTY10
PCT0009-09	Contact Tip Steel (0.9mm)	QTY10
PCT0009-10	Contact Tip Steel (1.0mm)	QTY10
PCT0009-12	Contact Tip Steel (1.2mm)	QTY10
PCT0009-16	Contact Tip Steel (1.6mm)	QTY10
PCTAL0009-09	Contact Tip Aluminium (0.9mm)	QTY10
PCTAL0009-10	Contact Tip Aluminium (1.0mm)	QTY10
PCTAL0009-12	Contact Tip Aluminium (1.2mm)	QTY10

SB24 Tip Holder

Part Number	Description	QTY
PCTH24	Contact Tip Holder	QTY2

SB24 Gas Diffuser

Part Number	Description	QTY
PCGD24	Gas Diffuser	QTY2
PCGD24R	Rubber Gas Diffuser	QTY2

SB24 Gas Nozzle

Part Number	Description	QTY
PGN24CYL	Cylindrical Nozzle	QTY2
PGN24CON	Conical Nozzle	QTY2
PGN24TAP	Tapered Nozzle	QTY2
PGN24SPOT	Spot Nozzle	QTY2

V Groove Drive Roller - Steel Wire

Part Number	Description
UGP7020W-09	Driver Roll For Hard Wire 0.9
UGP7020W-10	Driver Roll For Hard Wire 1.0

U Groove Drive Roller - Soft Wire

Part Number	Description
UGP7020W-08U	Driver Roll For Aluminium Wire 0.8
UGP7020W-09U	Driver Roll For Aluminium Wire 0.9
UGP7020W-10U	Driver Roll For Aluminium Wire 1.0
UGP7020W-12U	Driver Roll For Aluminium Wire 1.2

These parts are manufactured in China and are offered as replacement parts suitable for "BINZEL®" style torches.

SR26V ERGO TIG TORCH

200A AIR COOLED TIG WELDING TORCH

Rating: 200Amp DC, 140Amp AC @35% duty cycle.



Suregrip Series

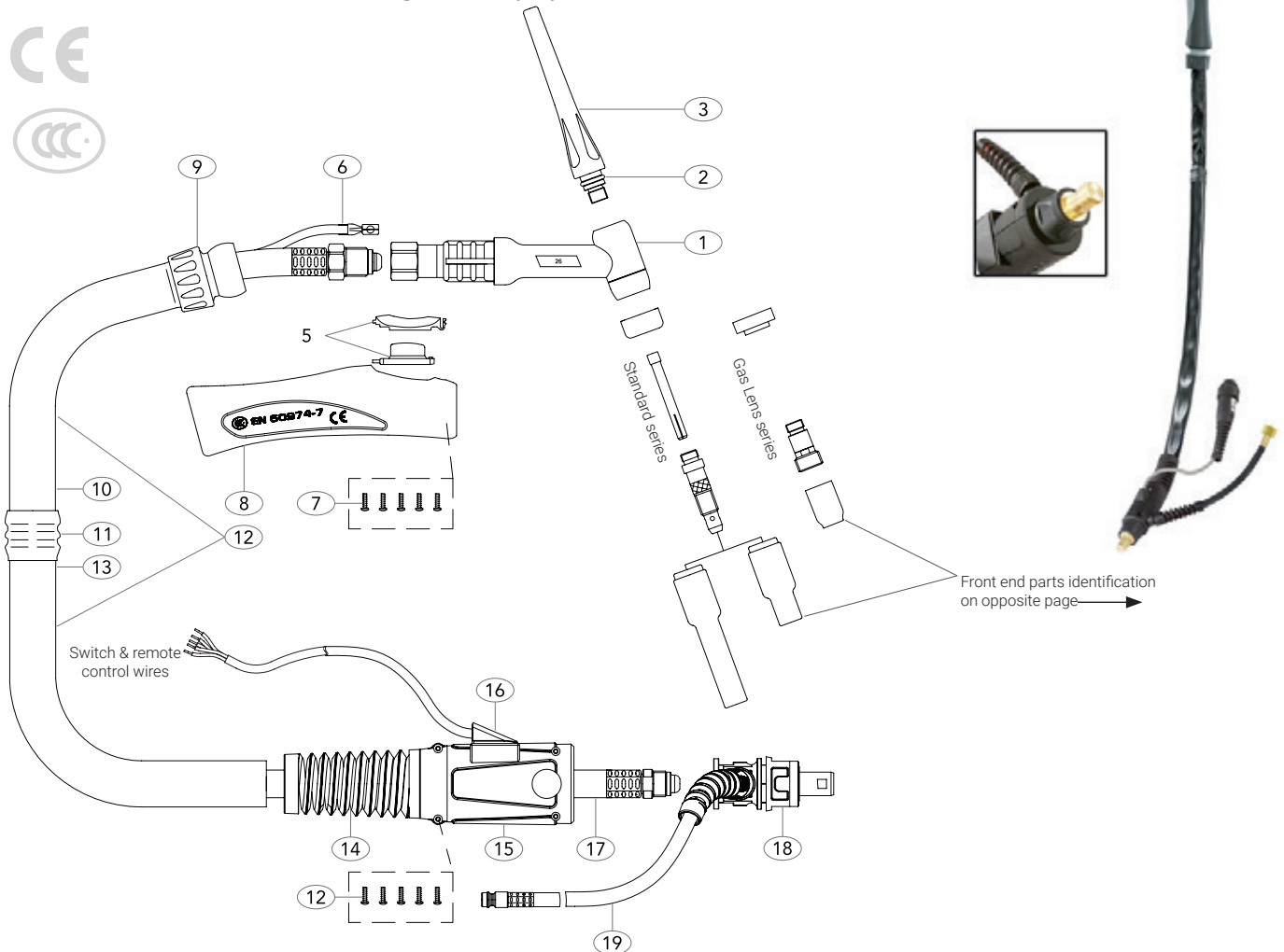

Torch Model		
Description	Part Number	
	4m	8m
SR26 Suregrip Tig Torch Package c/w QF Gas Connect	SR-26-4MCP50	SR-26-8MCP50
	SR-26-4MCP25	SR-26-8MCP25

Spare Parts	
Part Number	Description
1	WP26 Torch head
	WP26V Torch head c/w valve
	WP26F Torch head flexible
	WP26VF Torch head flex c/w valve
	WP18 Torch head water-cooled
3	57Y02 Back cap long
3a	57Y03 Medium back cap
3b	57Y04 Short back cap
8	HWP26 Torch handle

©All rights reserved. No part of this publication may be reproduced, stored in a retrieval system or transmitted by any means, electronic, mechanical, photocopying or otherwise without the prior permission of ©Uniar© the copyright holder.

SR26V ERGO TIG TORCH

Standard Front End Parts

Part # 18CG
Description Cup Gasket



Part # 10N30
10N31
10N32
10N28
Description Collet Body 1.0mm
Collet Body 1.6mm
Collet Body 2.4mm
Collet Body 3.2mm

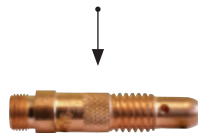

Part # 10N49L
53N48L
53N47L
Description Long Alumina Nozzle Ø 8mm #5L
Long Alumina Nozzle Ø 10mm #6L
Long Alumina Nozzle Ø 11mm #7L



Part # 10N22
10N23
10N24
10N25
Description Collet 1.0mm
Collet 1.6mm
Collet 2.4mm
Collet 3.2mm

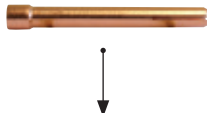

Part # 10N50
10N49
10N48
10N47
10N46
10N45
10N44
Description Alumina Nozzle Ø 6mm #4
Alumina Nozzle Ø 8mm #5
Alumina Nozzle Ø 10mm #6
Alumina Nozzle Ø 11mm #7
Alumina Nozzle Ø 13mm #8
Alumina Nozzle Ø 16mm #10
Alumina Nozzle Ø 19mm #12



Compact Gas Lens Front End Parts

Part # 54N01
Description Gas Lens Gasket



Part # 45V25
45V26
45V27
Description Gas Lens Body 1.6mm
Gas Lens Body 2.4mm
Gas Lens Body 3.2mm

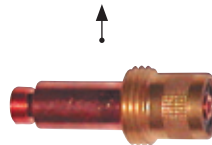

Part # 54N14
54N15
54N17
Description Gas lens ceramic 8.0mm
Gas lens ceramic 7.0mm
Gas lens ceramic 5.0mm

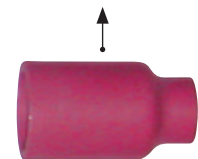

TR0004-16



RED
ANSI/AWS A5.12-98
ISO 6848 WT20

2% Thoriated: Best stability at medium currents, good arc starts, medium tendency to spit, medium erosion rate. Commonly used for steel and stainless steel applications

1/16 x 7" (1.6mm x 175mm)
3/32 x 7" (2.4mm x 175mm)
1/8 x 7" (3.2mm x 175mm)

Part #	Description
TR0004-10	1.0mm x 175mm thoriated tungsten electrode 2%
TR0004-16	1.6mm x 175mm thoriated tungsten electrode 2%
TR0004-24	2.4mm x 175mm thoriated tungsten electrode 2%
TR0004-32	3.2mm x 175mm thoriated tungsten electrode 2%

TR0006-16



WHITE
ANSI/AWS A5.12 M-98
ISO 6848 WZ8

.8% Zirconiated: Balls well, handles higher current with less spitting, better arc starts and arc stability than pure tungsten. Commonly used for aluminium applications

1/16 x 7" (1.6mm x 175mm)
3/32 x 7" (2.4mm x 175mm)
1/8 x 7" (3.2mm x 175mm)

Part #	Description
TR0006-10	1.0mm x 175mm zirconiated tungsten electrode 1%
TR0006-16	1.6mm x 175mm zirconiated tungsten electrode 1%
TR0006-24	2.4mm x 175mm zirconiated tungsten electrode 1%
TR0006-32	3.2mm x 175mm zirconiated tungsten electrode 1%

MIG WELDING TROUBLE SHOOTING

The following chart addresses some of the common problems of MIG welding. In all cases of equipment malfunction, the manufacturer's recommendations should be strictly adhered to and followed.

1: Excessive Spatter	
<i>Possible Reason</i>	<i>Suggested Remedy</i>
Wire feed speed set too high	Select lower wire feed speed
Voltage too high	Select a lower voltage setting
Wrong polarity set	select the correct polarity for the wire being used - see machine setup guide
Stick out too long	Bring the torch closer to the work
Contaminated base metal	Remove materials like paint, grease, oil, and dirt, including mill scale from base metal
Contaminated mig wire	Use clean dry rust free wire. Do not lubricate the wire with oil, grease etc
Inadequate gas flow or too much gas flow	Check the gas is connected, check hoses, gas valve and torch are not restricted. Set the gas flow between 6-12 l/min flow rate. Check hoses and fittings for holes, leaks etc Protect the welding zone from wind and drafts
2: Porosity - small cavities or holes resulting from gas pockets in weld metal.	
<i>Possible Reason</i>	<i>Suggested Remedy</i>
Wrong gas	Check that the correct gas is being used
Inadequate gas flow or too much gas flow	Check the gas is connected, check hoses, gas valve and torch are not restricted. Set the gas flow between 10 - 15 l/min flow rate. Check hoses and fittings for holes, leaks etc. Protect the welding zone from wind and drafts
Moisture on the base metal	Remove all moisture from base metal before welding
Contaminated base metal	Remove materials like paint, grease, oil, and dirt, including mill scale from base metal
Contaminated mig wire	Use clean dry rust free wire. Do not lubricate the wire with oil, grease etc
Gas nozzle clogged with spatter, worn or out of shape	Clean or replace the gas nozzle
Missing or damaged gas diffuser	Replace the gas diffuser
Mig torch euro connect o-ring missing or damaged	check and replace the o-ring
3: Wire stubbing during welding	
<i>Possible Reason</i>	<i>Suggested Remedy</i>
Holding the torch too far away	Bring the torch closer to the work and maintain stick out of 5-10mm
Welding voltage set too low	Increase the voltage
Wire Speed set too high	Decrease the wire feed speed
4: Lack of Fusion – failure of weld metal to fuse completely with base metal or a preceding weld bead.	
<i>Possible Reason</i>	<i>Suggested Remedy</i>
Contaminated base metal	Remove materials like paint, grease, oil, and dirt, including mill scale from base metal
Not enough heat input	Select a higher voltage range and /or adjust the wire speed to suit
Improper welding technique	Keep the arc at the leading edge of the weld pool. Gun angle to work should be between 5 & 15° Direct the arc at the weld joint Adjust work angle or widen groove to access bottom during welding Momentarily hold arc on side walls if using weaving technique
5: Excessive Penetration – weld metal melting through base metal	
<i>Possible Reason</i>	<i>Suggested Remedy</i>
Too much heat	Select a lower voltage range and /or adjust the wire speed to suit Increase travel speed
6: Lack of Penetration – shallow fusion between weld metal and base metal	
Poor in incorrect joint preparation	Material too thick. Joint preparation and design needs to allow access to bottom of groove while maintaining proper welding wire extension and arc characteristics Keep the arc at the leading edge of the weld pool and maintain the gun angle at 5 & 15° keeping the stick out between 5-10mm
Not enough heat input	Select a higher voltage range and /or adjust the wire speed to suit Reduce travel speed
Contaminated base metal	Remove materials like paint, grease, oil, and dirt, including mill scale from base metal.

MIG WIRE FEED TROUBLE SHOOTING

The following chart addresses some of the common WIRE FEED problems during MIG welding. In all cases of equipment malfunction, the manufacturer's recommendations should be strictly adhered to and followed.

1: No wire feed	
<i>Possible Reason</i>	<i>Suggested Remedy</i>
Wrong mode selected	Check that the TIG/MMA/MIG selector switch set to MIG position
Wrong torch selector switch	Check that the STANDARD/SPOOLGUN selector switch is set to STANDARD position for MIG welding and SPOOLGUN when using the Spoolgun
2: Inconsistent / interrupted wire feed	
<i>Possible Reason</i>	<i>Suggested Remedy</i>
Adjusting wrong dial	Be sure to adjust the WIRE FEED and VOLTAGE dials for MIG welding. The AMPERAGE dial is for STICK and TIG welding mode
Wrong polarity selected	Select the correct polarity for the wire being used - see machine setup guide
Incorrect wire speed setting	Adjust the wire feed speed
Voltage setting incorrect	Adjust the voltage setting
Mig torch lead too long	Small diameter wires and soft wires like aluminium don't feed well through long torch leads - replace the torch with a lesser length torch
Mig torch lead kinked or too sharp angle being held	Remove the kink, reduce the angle or bend
Contact tip worn, wrong size, wrong type	Replace the tip with correct size and type
Liner worn or clogged (the most common causes of bad feeding)	Try to clear the liner by blowing out with compressed air as a temporary cure, it is recommended to replace the liner
Wrong size liner	Install the correct size liner
Blocked or worn inlet guide tube	Clear or replace the inlet guide tube
Wire misaligned in drive roller groove	Locate the wire into the groove of the drive roller
Incorrect drive roller size	Fit the correct size drive roller eg; 0.8mm wire requires 0.8mm drive roller
Wrong type of drive roller selected	Fit the correct type roller (e.g. knurled rollers needed for flux cored wires)
Worn drive rollers	Replace the drive rollers
Drive roller pressure too high	Can flatten the wire electrode causing it to lodge in the contact tip - reduce the drive roller pressure
Too much tension on wire spool hub	Reduce the spool hub brake tension
Wire crossed over on the spool or tangled	Remove the spool untangle the wire or replace the wire
Contaminated mig wire	Use clean dry rust free wire. Do not lubricate the wire with oil, grease etc

TIG WELDING TROUBLE SHOOTING

The following chart addresses some of the common problems of DC TIG welding. In all cases of equipment malfunction, the manufacturer's recommendations should be strictly adhered to and followed.

1: Tungsten burning away quickly	
<i>Possible Reason</i>	<i>Suggested Remedy</i>
Incorrect Gas or No Gas	Use pure Argon. Check cylinder has gas, connected, turned on and torch valve is open
Inadequate gas flow	Check the gas is connected, check hoses, gas valve and torch are not restricted.
Back cap not fitted correctly	Make sure the torch back cap is fitted so that the o-ring is inside the torch body
Torch connected to DC +	Connect the torch to the DC- output terminal
Incorrect tungsten being used	Check and change the tungsten type if necessary
Tungsten being oxidised after weld is finished	Keep shielding gas flowing 10–15 seconds after arc stoppage. 1 second for each 10 amps of weld current.
2: Contaminated tungsten	
<i>Possible Reason</i>	<i>Suggested Remedy</i>
Touching tungsten into the weld pool	Keep tungsten from contacting weld puddle. Raise the torch so that the tungsten is off of the work piece 2 - 5mm
Touching the filler wire to the tungsten	Keep the filler wire from touching the tungsten during welding, feed the filler wire into the leading edge of the weld pool in front of the tungsten
3: Porosity - poor weld appearance and colour	
<i>Possible Reason</i>	<i>Suggested Remedy</i>
Wrong gas / poor gas flow /gas leaks	Use pure argon. Gas is connected, check hoses, gas valve and torch are not restricted. Set the gas flow between 6-12 l/min. Check hoses and fittings for holes, leaks etc.,
Contaminated base metal	Remove moisture and materials like paint, grease, oil, and dirt from base metal
Contaminated filler wire	Remove all grease, oil, or moisture from filler metal.
Incorrect filler wire	Check the filler wire and change if necessary
4: Yellowish residue / smoke on the alumina nozzle & discoloured tungsten	
<i>Possible Reason</i>	<i>Suggested Remedy</i>
Incorrect Gas	Use pure Argon gas
Inadequate gas flow	Set the gas flow between 10 - 15 l/min flow rate
Alumina gas nozzle too small	Increase the size of the alumina gas nozzle
5: Unstable Arc during DC welding	
<i>Possible Reason</i>	<i>Suggested Remedy</i>
Torch connected to DC +	Connect the torch to the DC- output terminal
Contaminated base metal	Remove materials like paint, grease, oil, and dirt, including mill scale from base metal.
Tungsten is contaminated	Remove 10mm of contaminated tungsten and re grind the tungsten
Arc length too long	Lower torch so that the tungsten is off of the work piece 2 - 5mm
6: Arc wanders during DC welding	
<i>Possible Reason</i>	<i>Suggested Remedy</i>
Poor gas flow	Check and set the gas flow between 10 - 15 l/min flow rate
Incorrect arc length	Lower torch so that the tungsten is off of the work piece 2 - 5mm
Tungsten incorrect or in poor condition	Check that correct type of tungsten is being used. Remove 10mm from the weld end of the tungsten and re sharpen the tungsten
Poorly prepared tungsten	Grind marks should run lengthwise with tungsten, not circular. Use proper grinding method and wheel.
Contaminated base metal or filler wire	Remove contaminating materials like paint, grease, oil, and dirt, including mill scale from base metal. Remove all grease, oil, or moisture from filler metal.
7: Arc difficult to start or will not start DC welding	
<i>Possible Reason</i>	<i>Suggested Remedy</i>
Incorrect machine set up	Check machine set up is correct
No gas, incorrect gas flow	Check the gas is connected and cylinder valve open, check hoses, gas valve and torch are not restricted. Set the gas flow between 10 - 15 l/min flow rate
Incorrect tungsten size or type	Check and change the size and or the tungsten if required
Loose connection	Check all connectors and tighten
Earth clamp not connected to work	Connect the earth clamp directly to the work piece wherever possible

MMA (Stick) WELDING TROUBLE SHOOTING

The following chart addresses some of the common problems of MMA welding. In all cases of equipment malfunction, the manufacturer's recommendations should be strictly adhered to and followed.

1: No arc	
<i>Possible Reason</i>	<i>Suggested Remedy</i>
Incomplete welding circuit	Check earth lead is connected. Check all cable connections.
Wrong mode selected	Check the MMA selector switch is selected
No power supply	Check that the machine is switched on and has a power supply
2: Porosity – small cavities or holes resulting from gas pockets in weld metal.	
<i>Possible Reason</i>	<i>Suggested Remedy</i>
Arc length too long	Shorten the arc length
Work piece dirty, contaminated or moisture	Remove moisture and materials like paint, grease, oil, and dirt, including mill scale from base metal
Damp electrodes	Use only dry electrodes
3: Excessive Spatter	
<i>Possible Reason</i>	<i>Suggested Remedy</i>
Amperage too high	Decrease the amperage or choose a larger electrode
Arc length too long	Shorten the arc length
3: Weld sits on top, lack of fusion	
<i>Possible Reason</i>	<i>Suggested Remedy</i>
Insufficient heat input	Increase the amperage or choose a larger electrode
Work piece dirty, contaminated or moisture	Remove moisture and materials like paint, grease, oil, and dirt, including mill scale from base metal
Poor welding technique	Use the correct welding technique or seek assistance for the correct technique
4: Lack of penetration	
<i>Possible Reason</i>	<i>Suggested Remedy</i>
Insufficient heat input	Increase the amperage or choose a larger electrode
Poor welding technique	Use the correct welding technique or seek assistance for the correct technique
Poor joint preparation	Check the joint design and fit up, make sure the material is not too thick. Seek assistance for the correct joint design and fit up
5: Excessive penetration - burn through	
<i>Possible Reason</i>	<i>Suggested Remedy</i>
Excessive heat input	Reduce the amperage or use a smaller electrode
Incorrect travel speed	Try increasing the weld travel speed
6: Uneven weld appearance	
<i>Possible Reason</i>	<i>Suggested Remedy</i>
Unsteady hand, wavering hand	Use two hands where possible to steady up, practise your technique
7: Distortion – movement of base metal during welding	
<i>Possible Reason</i>	<i>Suggested Remedy</i>
Excessive heat input	Reduce the amperage or use a smaller electrode
Poor welding technique	Use the correct welding technique or seek assistance for the correct technique
Poor joint preparation and or joint design	Check the joint design and fit up, make sure the material is not too thick. Seek assistance for the correct joint design and fit up
7: Electrode welds with different or unusual arc characteristic	
<i>Possible Reason</i>	<i>Suggested Remedy</i>
Incorrect polarity	Change the polarity, check the electrode manufacturer for correct polarity

Spare Parts Identification - MIG350K-SG (N271)

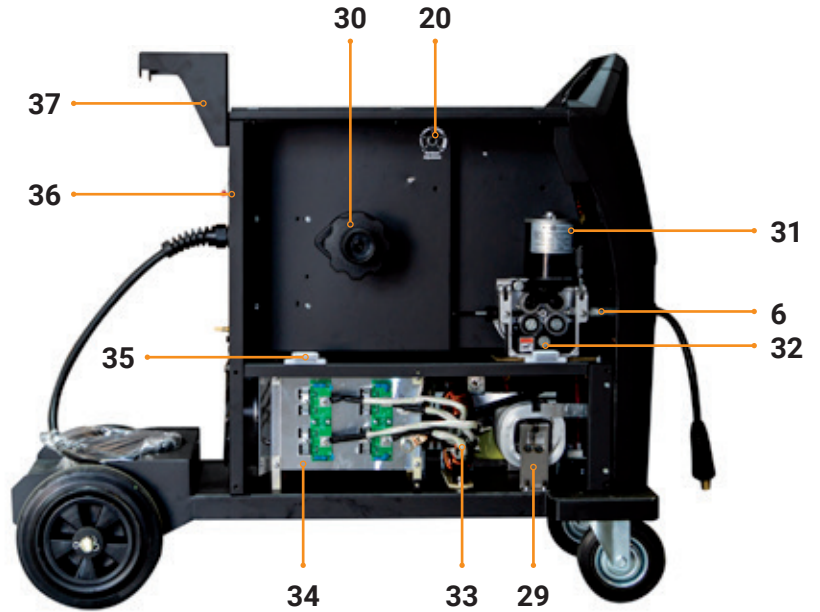
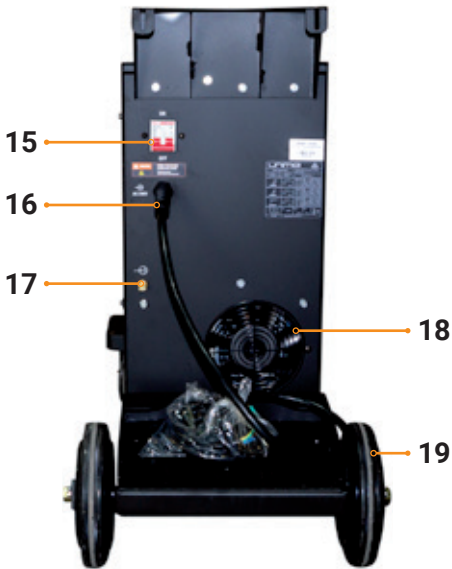
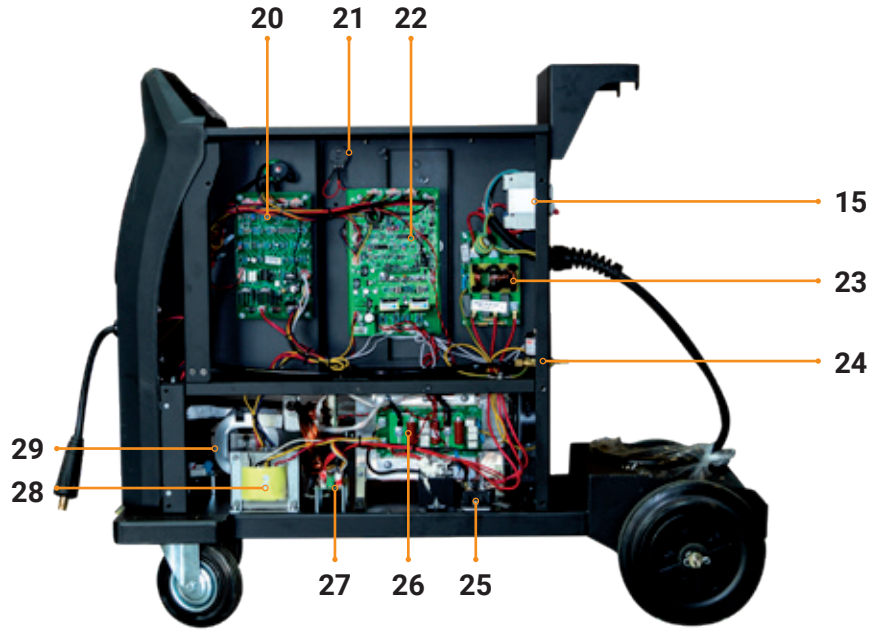
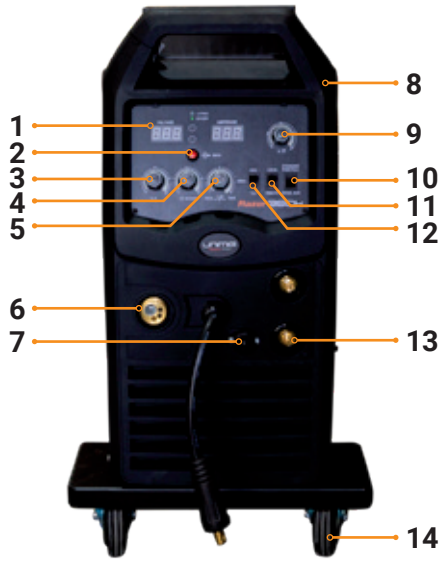

#	Part Number	Description	#	Part Number	Description
1	10046713	DIGITAL METER (VOLT AND AMP)	25	10005913	CAPACITOR 40μF 1250VDC
2	10062475	INC SWITCH 2A/250V	26	10001960	IGBT PCB (PN-38)
3	10062473	POT FOR VOLTAGE ADJUSTMENT 4.7K 2W	27	10000849	POWER DISTRIBUTION PCB
4	10064233	POT FOR WIRE SPEED ADJUSTMENT 1K 2W	28	10020675	CONTROL TRANSFORMER
5	10062487	POT FOR INDUCTANCE ADJUSTMENT	29	10062588	CHOKE N271-30/A1
6	10062485	CENTRAL ADAPTOR	30	10027736	SPOOL HOLDER ASSEMBLY
7	10064249	SPOOL GUN 9PIN PANEL SOCKET	31	10022066	WIRE FEED MOTOR
8	10062911	PLASTIC FRONT PANEL	32		WIRE FEED BRACKET
9	10062473	POT FOR CURRENT ADJUSTMENT 4.7K 2W	33	10006182	MAIN TRANSFORMER
10	10062480	SPOOL GUN/STANDARD SELECTOR SWITCH	34	10000332	OUTPUT DIODES PCB (PD-43)
11	10062441	LOCAL/REMOTE SELECTOR SWITCH	35		DOOR LATCH
12	10062441	MIG/MMA/TIG SELECTOR SWITCH	36	10064475	REAR PANEL
13	10004638	DINSE CONNECTOR PANEL 35/50	37		BOTTLE RETAINING BRACKET
14	10016534	FRONT SWIVEL WHEEL		10000835	VOLTAGE FEEDBACK PCB
15	10062485	MAIN SWITCH		10000870	PEAK CURRENT SENSOR PCB
16	10004895	INPUT CABLE COUPLER		10064484	BLACK METALCOVER FOR SIDES TOP RIGHT
17	10001389	GAS SOLENOID VALVE 24 VDC		10064479	BLACK METALCOVER FOR SIDES BOTTOM RIGHT
18	10001864	FAN MOTOR 230 V AC		10064481	BLACK METAL COVER FOR SIDE BOTTOM LEFT
19	10016535	REAR FIXED WHEEL		10062705	BASE PLATE
20	10000891	POWER SUPPLY AND WIRE FEED PCB (PH-119)			DOOR PANEL
21	10062487	POT FOR BURN BACK CONTROL		SP2110-P9	SPOOL GUN 9 PIN PLUG
22	10000648	CONTROL PCB (PK-131)		30000130	TURNING KNOB
23	10027249	EMC BOARD		10062762	THERMAL SWITCH (OHD-80M)
24	10006635	INPUT BRIDGE RECTIFIER (MSD60A/1200V)			

Welding Guns Of Australia Pty Ltd ('Us', 'We') warrants that the following products under UNI-MIG, UNI-TIG, UNI-PLAS, UNI-FLAME, TECNA, T&R, HIT-8SS & ROTA, supplied by Us and purchased by you from an Authorised UNI-MIG, UNI-TIG, UNI-PLAS, UNI-FLAME, TECNA, T&R, HIT-8SS & ROTA Dealer throughout Australia are free of Material and Faulty Workmanship defects except for those products listed under 'Warranty Exclusions'.

These terms and conditions supersede and exclude all former and other representations and arrangements relating to any warranties on these products.

WARRANTY PERIOD

We offer the following 'Warranty Periods' from 'date of purchase':

An Extended Warranty Period of 6 months total shall apply only to Machinery where offered and warranty is registered online.

UNI-MIG WELDING MACHINES

UNI-MIG DIY Series (Power Source Only)	2 Years	(Clause 3)
UNI-MIG Procraft Series (Power Source Only)	3 Years	(Clause 1&3)
UNI-MIG Trade Series (Power Source Only)	3 Years	(Clause 1&3)
UNI-MIG Trade Series SWF (Power Source / Separate Wire Feeder Only)	3 Years	(Clause 1&3)
UNI-MIG Workshop Series (Power Source Only)	3 Years	(Clause 1&3)
UNI-MIG Workshop Series SWF (Power Source / Separate Wire Feeder Only)	3 Years	(Clause 1&3)
UNI-MIG Jasic Inverter MIG (Power Source Only)	3 Years	(Clause 3)
UNI-MIG Jasic Inverter MIG SWF (Power Source / Separate Wire Feeder Only)	3 Years	(Clause 3)
UNI-TIG Jasic Inverter TIG (Power Source Only)	3 Years	(Clause 3)
UNI-MIG Water Cooler	1 Year	(Clause 3)
T&R Pulse MIG (Power Source Only)	2 Year	(Clause 3)
T&R Pulse MIG SWF (Power Source / Separate Wire Feeder Only)	2 Year	(Clause 3)
UNI-PLAS (Power Source Only)	3 Years	(Clause 3)
UNI-PLAS Jasic Series (Power Source Only)	2 Years	(Clause 3)
UNI-PLAS Site Cut Series (Power Source Only)	1 Year	(Clause 3)
UNI-FLAME Gas Cutting and Welding Kits	3 Months	(Clause 2&3)
UNI-FLAME Straight Line & Gas Cutting Machines (Power Source Only)	1 Year	(Clause 3)
UNI-FLAME Regulators Argon/ Acetylene / Oxygen / LPG / Bobbin Flowmeter	1 Year	
UNI-FLAME Automatic Welding Helmet	2 Years	
UNI-MIG Automatic Welding Helmets	2 Years	
TECNA (Power Source Only)	1 Year	(Clause 3)
HIT-8SS Automatic Carriage (Power Source Only)	1 Year	(Clause 3)
ROTA 102 Rotating table	1 Year	
HOTBOX ElectrodeOven	1 Year	
SPOTCAR 3500	1 Year	(Clause 3)
TORCHES -GMAW, GTAW, MMAW, PLASMA, EARTH LEADS, INTERCONNECTING CABLES, GAS HOSE	3 Months	(Clause 3)

(Clause 1) 3 year warranty on transformers, inductor and rectifier. 1 year warranty on PCB, and all other components, .

(Clause 2) Gas Hose, Flashbacks are subject to and covered by the Manufacture's Individual Warranty, Contact the manufacturer for details

(Clause 3) This only Covers Manufactures defaults on all accessories for the first three months after date of purchase.

WARRANTY / RETURNS / EXCHANGES

We understand that sometimes you may need to return a product you have purchased from Welding Guns Of Australia PTY LTD Authorised Dealer Network, to assist you, we have set out below the Welding Guns Of Australia PTY LTD Returns Policy that you should know.

Our Returns Policy includes the rights you have under the Australian Consumer Law and other relevant laws.

Your Rights under the Australian Consumer Law - Our goods come with guarantees that cannot be excluded under the Australian Consumer Law. You are entitled to a replacement or refund for a major failure and for compensation for any other reasonably foreseeable loss or damage. You are also entitled to have the goods repaired or replaced if the goods fail to be of acceptable quality and the failure does not amount to a major failure.

- You shall inspect the Goods on delivery and shall within seven (7) days of delivery (time being of the essence) notify Welding Guns Of Australia PTY LTD of any alleged defect, shortage in quantity, damage or failure to comply with the description or quote.
- You shall also afford Welding Guns Of Australia PTY LTD the opportunity to inspect the Goods within a reasonable time following delivery if you believe the Goods are defective in any way.
- If you shall fail to comply with these provisions the Goods shall be presumed to be free from any defect or damage. For defective Goods, which Welding Guns Of Australia PTY LTD has agreed in writing that you are entitled to reject, Welding Guns Of Australia PTY LTD liability is limited to either (at the Welding Guns Of Australia PTY LTD discretion) replacing the Goods or repairing the Goods except where you have acquired Goods as a consumer within the meaning of the Trade Practices Act 1974 or the Fair Trading Acts of the relevant state or territories of Australia, and is therefore also entitled to, at the consumer's discretion either a refund of the purchase price of the Goods, or repair of the Goods, or replacement of the Goods.

Returns will only be accepted provided that:

- a. You have complied with the provisions outlined above, and
 - b. where the Goods are unable to be repaired, the Goods are returned at your cost within thirty (30) days of the delivery date, and
 - c. Welding Guns Of Australia PTY LTD will not be liable for Goods which have not been stored or used in a proper manner, and
 - d. the Goods are returned in the condition in which they were delivered and with all packaging material, brochures and instruction material in as new condition as is reasonably possible in the circumstances.
- Welding Guns Of Australia PTY LTD Accepts no responsibility for products lost, damaged or mislaid whilst in transit
 - Welding Guns Of Australia PTY LTD may (at their sole discretion) accept the return of Goods for credit but this may incur a handling fee of up to fifteen percent (15%) of the value of the returned Goods plus any freight costs.
 - Where a failure does not amount to a major failure, Welding Guns Of Australia PTY LTD is entitled to choose between providing you with a repair, replacement or other suitable remedy.
 - Your rights under the Australian Consumer Law are not limited by a defined time. However, the Australian Consumer Law does recognise that the relevant time period can vary from product to product, depending on factors such as the nature of the product and the price. Welding Guns Of Australia PTY LTD adopts the same approach. As you can appreciate, the type of remedy we can offer you may also vary depending on how long it takes you to return the product to us.

MAKING A CLAIM

If you wish to make a claim under this Warranty, you should:

- Return the product to the point of purchase either in person or on a prepaid courier; or
- Contact Us by Telephone on 02 9870 4200 or Mail PO Box 3033 Lansvale NSW 2166.

When returned, the product must be accompanied with the original invoice including the purchase price and disclosing the purchase date

All costs of installation, cartage, freight, travelling expenses, hiring tools and insurance are paid by the Customer.

To the extent permitted by law, our total liability for loss or damage of every kind related to the product in any way whatsoever is limited to the amount paid to the retailer by you for the product or the value of the product.

No responsibility will be taken for products lost, damaged or mislaid whilst in transit.

WARRANTY EXCLUSIONS

This Warranty covers Material and Faulty Workmanship defects only.

This Warranty does not cover damage caused by:

- Normal wear and tear due to usage
- Misuse or abusive use of the UNI-MIG, UNI-TIG, UNI-PLAS, UNI-FLAME, TECNA, T&R, HIT-8SS & ROTA, instructions supplied with the product.
- Failure to clean or improper cleaning of the product
- Failure to maintain the equipment such as regular services etc
- Incorrect voltage or non-authorized electrical connections
- Improper installation
- Use of non-authorized/non-standard parts
- Abnormal product performance caused by any ancillary equipment interference or other external factors
- Failure or any breakage caused by overload, dropping or abusive treatment or use by the customer
- Repair, modifications or other work carried out on the product other than by an Authorized UNI-MIG, UNI-TIG, UNI-PLAS, UNI-FLAME, TECNA, T&R, HIT-8SS & ROTA Service Dealer

Unless it is a manufacturing fault, this Warranty does not cover the following parts:

MIG Welding Torches and Consumables to suit, such as:

Gas Nozzels, Gas Diffusers, Contact Tip holder, Contact tip, Swan Necks, Trigger, Handle, Liners, Wire Guide, Drive Roller, Gas Nozzle Spring, Neck Spring, Connector Block, Insulator, Gas Nipple, Cap, Euro Block, Head Assembly, Gas Block, Trigger Spring, Spring Cable Support, Neck Insulator, Shroud Spring, Gun Plug Cover, Lock Nut, Snap On Head, Spring Cap, Ball, Motor 42 Volt, Pot 10K standard, Knob, Drive Roll Seat, Washer, Bow, Ball Bearing, Wire Conduite Nipple, Central Plug, Printed Circuit Board, Gun Plug House, Cable Support, Gas Connector, Handle To Suit PP36 with Knobs, All Xcel-Arc/ Magmaweld Mig Welding Wires & Electrodes, Arc Leads, Welding Cable, Electrode Holder, Eatch Clamps

TIG Welding Torches and Consumables to suit, such as:

Tungsten Electrodes, Collet, Collet Body, Alumina Nozzle, Torch Head, Torch Head water Cooled, Torch Head Flexible, Back Caps, Gas Lens, Torch Handle, Cup Gasket, Torch Body Gas Valve, O-ring, All UNI-MIG TIG Welding Rods, All Xcel-Arc/ Magmaweld Electrodes, Arc Leads, Welding Cable, Electrode Holder, Eatch Clamps.

PLASMA Cutting Torches and Consumables to suit, such as:

All Cutting Tips, All Diffuser/Swirl Ring, All Electrode, Retaining Caps, Nozzle Springs, All Spacers, All Shield Caps, All Air and Power Cables, All Switches, All O-rings, All Springs, All Circle Guides and Cutting Kits, Torch Bodies, Air Filter Regulator, Arc Leads, Welding Cable, Electrode Holder, Eatch Clamps

STRAIGHT LINE CUTTING MACHINES and Consumables to suit, such as:

Hoses, Fittings, Track, Cutting Nozzles.

HIT-8SS Welding Carriage Consumables to suit, such as:

Input Cord, Inter-connecting Cord, Triggering Cable.

This Warranty does not cover products purchased:

- From a non-authorized UNI-MIG, UNI-TIG, UNI-PLAS, UNI-FLAME, TECNA, T&R, HIT-8SS & ROTA Dealer (such as purchases from unauthorized retailers and purchases over the Internet from unauthorized local/international sellers or sites such as EBay)
- At an auction;
- From a private seller

Unless it is a manufacturing fault, this Warranty does not apply to any products sold to Hire Companies.

These conditions may only be varied with the written approval of the Directors of Welding Guns Of Australia PTY LTD

REMEMBER TO RETAIN YOUR ORIGINAL INVOICE FOR PROOF OF PURCHASE.

UNIMIG

Welding Guns Of Australia Pty Ltd

ABN: 14 001 804 422

PO Box 3033, Lansvale NSW 2166, AUSTRALIA
112 Christina Rd, Villawood, NSW 2163

Phone: (02) 9780 4200

Fax: (02) 9780 4244

Email: sales@unimig.com.au

Web: www.unimig.com.au

© Welding Guns Of Australia PTY LTD 2018