



Optimal Solutions for the Future

PUMA 2100/2600/3100 series



**High Performance
Horizontal Turning
Center**

PUMA 2100
PUMA 2600
PUMA 3100

ver. EN 160502 SU

Basic information

Basic Structure
Cutting
Performance

Detailed Information

Options
Applications
Capacity Diagram
Specifications

Customer Support Service



PUMA

2100/2600/3100 series

PUMA 2100/2600/3100 series has been developed to create full line up of high level 8" to 12" size with model variations from 2 axis to Y axis and sub spindle.



Contents

02 Product Overview

Basic Information

04 Basic Structure

08 Cutting Performance

Detailed Information

10 Standard / Optional Specifications

12 Applications

13 Capacity Diagram

18 Machine / CNC Unit Specifications

26 Customer Support Service

High Performance

These Doosan machines offer a high level of machining capability to provide optimum productivity for the customer.

Wide Variation

A wide variety of machine specifications from 2-axis models to turning centers with sub spindles is available to meet your production requirements.

Easy Operation

User-friendly operation panel configurations, EZ Guide i and EOP(Easy Operation Package) can make easy and comfortable to use various features of the product.



Basic Structure

Basic information

Basic Structure
Cutting
Performance

Detailed Information

Options
Applications
Capacity Diagram
Specifications

Customer Support Service

Box guideways are applied to all axes to prevent vibration, secure dynamic rigidity, and ensure powerful and precise machining.

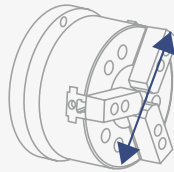

∅ 210 mm
(∅ 8.3 inch)

	PUMA 2100		2A / M / S / MS / Y / SY		
	PUMA 2100L		2A / M / S / MS / Y / SY		
Work length	520 (20.5)	760 (29.9)	1280 (50.4) mm (inch)	2125 (83.7)	3125 (123.0) mm (inch)

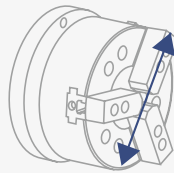

∅ 255 mm
(∅ 10 inch)

	PUMA 2600/500		2A / M		
	PUMA 2600		2A / M / S / MS / Y / SY		
	PUMA 2600L		2A / M / S / MS / Y / SY		
Work length	520 (20.5)	760 (29.9)	1280 (50.4) mm (inch)	2125 (83.7)	3125 (123.0) mm (inch)

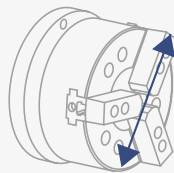

∅ 305 mm
(∅ 12 inch)

	PUMA 2600B		2A / M / S / MS / Y / SY		
	PUMA 2600LB		2A / M / Y		
	PUMA 3100		2A / M / Y		
	PUMA 3100L		2A / M / Y		
	PUMA 3100XL		2A / M / Y		
	PUMA 3100UL		2A / M / Y		
Work length	520 (20.5)	760 (29.9)	1280 (50.4) mm (inch)	2125 (83.7)	3125 (123.0) mm (inch)

High performance Y axis complex machining

Free operation in all directions of the rotary milling tool using Y axis control perform a variety of complex shape machining easily with high accuracy.

PUMA 2100 / 2600

105(±52.5)mm
(4.1 (±2.1) inch)

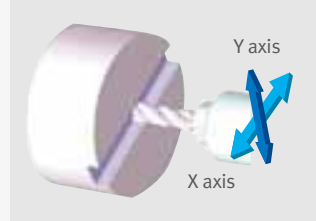

Groove finish cutting using the Y-axis

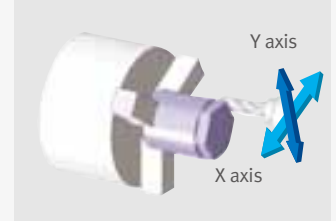

Multi-face cutting

PUMA 3100

130(±65)mm
(5.1 (±26) inch)

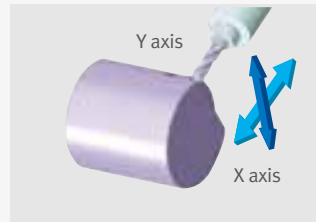

Milling in an eccentric position



Y & X axes circular interpolation

Machining area

These machines provide outstanding performance from general machining to large & long workpiece machining.

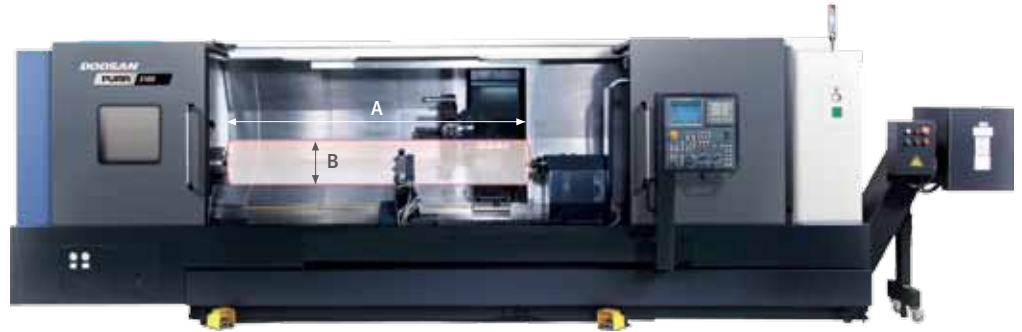

Unit : mm (inch)

Model	Max. turning length (A)	Max. turning dia. (B)
PUMA 2100 / S	545 (21.4)	481 (18.9)
PUMA 2100M / MS / Y / SY	520 (20.5)	406 (16.0)
PUMA 2100L / LS	785 (30.9)	481 (18.9)
PUMA 2100LM / LMS / LY / LSY	760 (29.9)	406 (16.0)
PUMA 2600 / S	790 (31.1)	481 (18.9)
PUMA 2600M / MS / Y / SY	760 (29.9)	376 (14.8)
PUMA 2600L / LS	1310 (51.6)	481 (18.9)
PUMA 2600LM / LMS / LY / LSY	1280 (50.4)	376 (14.8)
PUMA 2600/500	550 (21.7)	481 (18.9)
PUMA 2600M/500	520 (20.5)	376 (14.8)
PUMA 2600B / SB	755 (29.7)	481 (18.9)
PUMA 2600LB	1275 (50.2)	481 (18.9)
PUMA 2600MB / MSB / YB / SYB	725 (28.5)	376 (14.8)
PUMA 2600LMB / LYB	1245 (49.0)	376 (14.8)
PUMA 3100	790 (31.1)	525 (20.7)
PUMA 3100M / Y	765 (30.1)	420 (16.5)
PUMA 3100L	1310 (51.6)	525 (20.7)
PUMA 3100LM / LY	1285 (50.6)	420 (16.5)
PUMA 3100XL	2150 (84.7)	525 (20.7)
PUMA 3100XLM / XLY	2125 (83.7)	420 (16.5)
PUMA 3100UL	3150 (124.0)	525 (20.7)
PUMA 3100ULM / ULY	3125 (123.0)	420 (16.5)

Spindle

Basic information

Basic Structure
Cutting
Performance

Detailed Information

Options
Applications
Capacity Diagram
Specifications

Customer Support Service

Applying superior spindle motor & increase rigidity of headstock, to achieve stable performance during heavy & high speed machining.

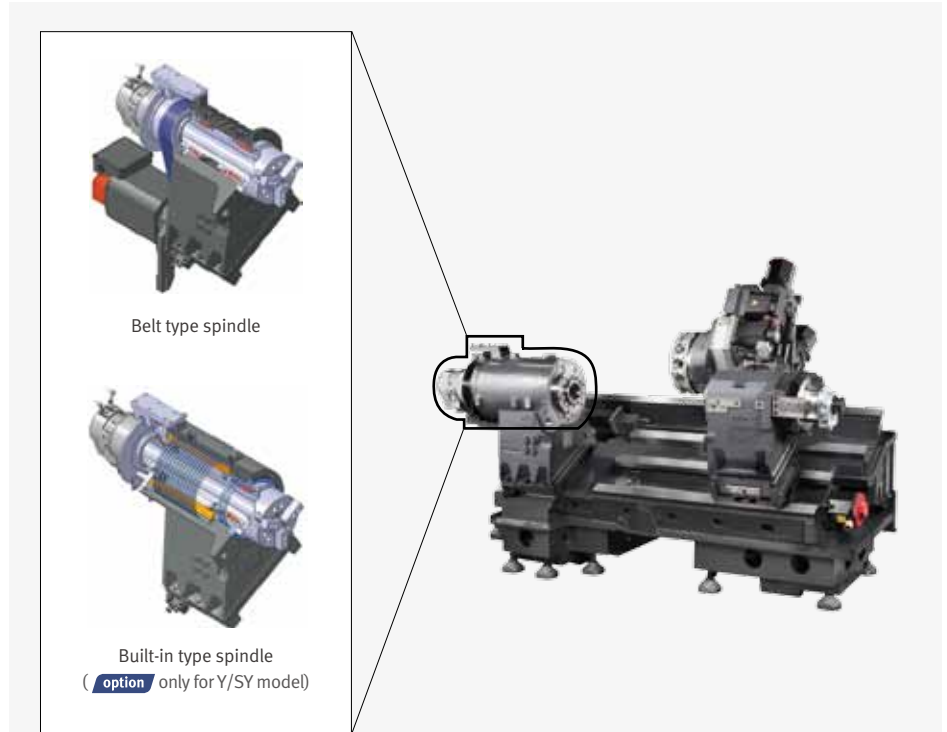

Model	Type	Max. speed r/min	Max. power kW (Hp)	Max. torque N-m (ft-lbs)
PUMA 2100	Belt	4500	18.5 (25)	183 (135)
	Built-in option	5000	22 (30)	358 (264)
PUMA 2600	Belt	3500	22 (30)	240 (177)
	Built-in option	4000	22 (30)	599 (442)
PUMA 2600B	Belt	2800	22 (30)	1123 (829)
PUMA 3100	Belt	2800	22 (30)	1123 (829)
	Built-in option	3000	30 (40)	1203 (888)

Sub spindle

Sub spindle function allow rear side cutting in a single setup.

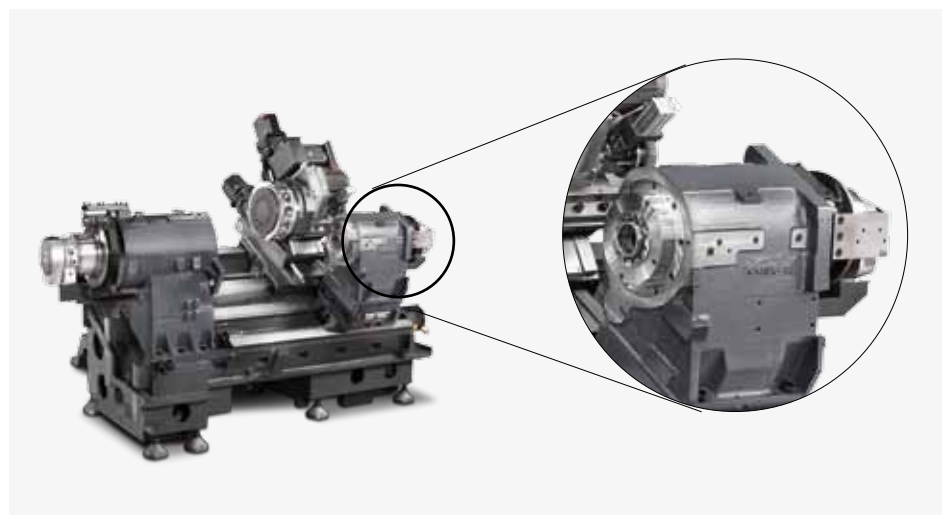

Model	Type	Max. speed r/min	Max. power kW (Hp)	Max. torque N-m (ft-lbs)
PUMA 2100 / PUMA 2600	Belt	4500	7.5 (10)	85 (61)
	Built-in option	6000	15 (20)	135 (100)

Turret

Turret rotation is controlled by servo motor for fast and reliable tool selection. Doosan's unique BMT turret design is used on M and Y specification models to boost heavy duty milling performance.

2-axis model

PUMA 2100 / 2600

No. of tool stations

12st

PUMA 3100

No. of tool stations

10st
12st option



M,Y Model

PUMA 2100 : BMT 55P

PUMA 2600 / 3100 : BMT 65P

No. of tool stations

12st

Position index

12^{index}
24^{index} option



16st turret for

Y axis model option

PUMA 2100 / 2600 : BMT 55P

No. of tool stations

16st

Position index

16^{index}

Available Model

- PUMA 2100Y / LY / SY / LSY
- PUMA 2600Y / LY / SY / LSY



Rotary tool power-torque diagram

Max. power : 5.5 kW (7 Hp)

Max. speed : 5000 r/min

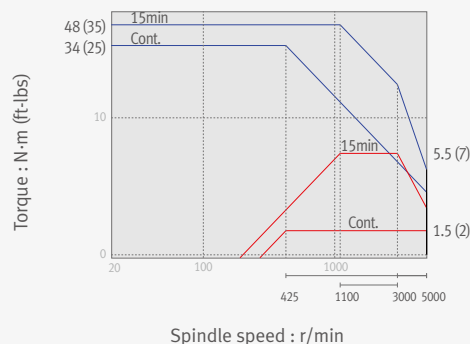

Rotary tool power-torque diagram option

Max. power : 7.5 kW (10 Hp)

Max. speed : 5000 r/min

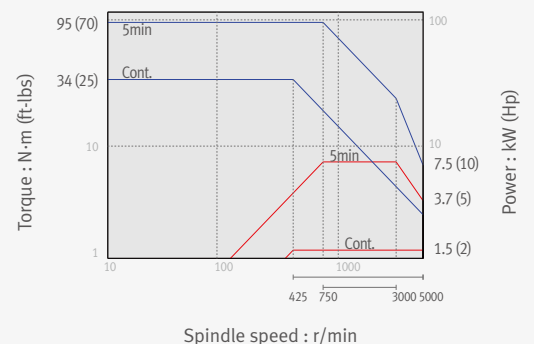



Tailstock

Basic information

Basic Structure
Cutting
Performance

Detailed Information

Options
Applications
Capacity Diagram
Specifications

Customer Support Service



High rigidity hydraulic tailstock is rigidly clamped to the bed slide way to provide stable support for long workpieces.



Tailstock type

- Manual
- Programmable
- Servo driven

Tailstock type

Tailstock type		PUMA 2100 / L series	PUMA 2600 / L series PUMA 3100 / L series	PUMA 3100XL / UL series
Manual 	Live center MT4	Standard	Not available	Not available
	Built-in center MT3	Option		
	Live center MT5	Not available	Standard	
	Built-in center MT4		Option	
Programmable 	Live center MT4	Option	Not available	Not available
	Built-in center MT3			
	Live center MT5	Not available	Option	
	Built-in center MT4			
	Built-in center MT5		Not available	
Servo driven 	Live center MT4	Option	Not available	Not available
	Built-in center MT3			
	Live center MT5	Not available	Option	
	Built-in center MT4			

Tailstock EZ function

In programmable tail stock, the Z-axis position of tail stock is recorded automatically as the clamped position of tail stock.



Cutting Performance

Multi-functionality including end milling, face milling, drilling, tapping, etc. offers better machining performance while minimizing work setting.

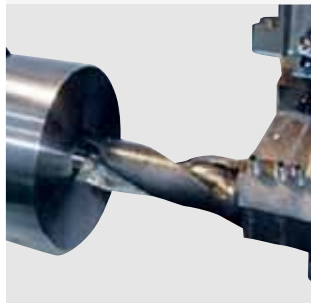
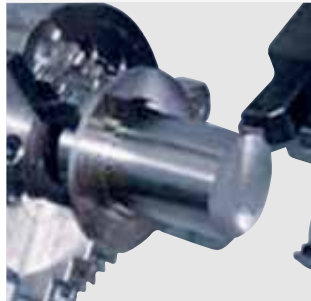
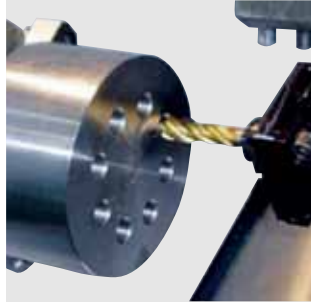
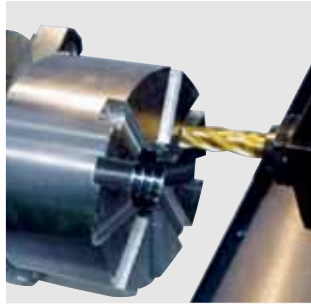

End mill		Carbon steel (SM45C)	
	Unit	PUMA 2100 BMT55P	PUMA 2600 BMT65P
Chip removal rate	cm ³ /min (inch ³ /min)	90 (35.43)	105 (41.34)
Tool Dia.	mm (inch)	18 (0.71)	20 (0.79)
Cutting Depth	mm (inch)	20 (0.79)	21 (0.83)
Feedrate	mm/min (ipm)	250 (9.8)	250 (9.8)

Tapping		Carbon steel (SM45C)	
	Unit	PUMA 2100 BMT55P	PUMA 2600 BMT65P
Rotary tool spindle speed	r/min	240	240
Tap Size		M20 x P2.5	M24 x P3
Feedrate	mm/min (ipm)	600 (23.6)	600 (23.6)

Face mill		Carbon steel (SM45C)	
	Unit	PUMA 2100 BMT55P	PUMA 2600 BMT65P
Chip removal rate	cm ³ /min (inch ³ /min)	41.9 (16.5)	53.9 (21.2)
Tool Dia.	mm (inch)	63 (2.5)	63 (2.5)
Cutting Depth	mm (inch)	3.5 (0.1)	4.5 (0.2)
Feedrate	mm/min (ipm)	190 (7.5)	190 (7.5)

O.D turning		Carbon steel (SM45C)	
	Unit	PUMA 2100 BMT55P	PUMA 2600 BMT65P
Chip removal rate	cm ³ /min (inch ³ /min)	528 (207.9)	616 (242.5)
Cutting Depth	mm (inch)	4.3 (0.2)	5.0 (0.2)
Feedrate	mm/rev (ipr)	0.55 (0.022)	0.55 (0.022)

U-Drill dia. (ø63 mm (2.5 inch))		Carbon steel (SM45C)	
	Unit	PUMA 2100	PUMA 2600
Chip removal rate	cm ³ /min (inch ³ /min)	472 (185.8)	630 (248.0)
Feedrate	mm/min (ipm)	0.15 (0.006)	0.2 (0.008)

Grooving		Carbon steel (SM45C)	
	Unit	PUMA 2100	PUMA 2600
Chip removal rate	cm ³ /min (inch ³ /min)	169 (66.54)	241 (94.9)
Cutting Depth	mm (inch)	8 (0.3)	8 (0.3)
Feedrate	mm/rev (ipr)	0.14 (0.006)	0.2 (0.008)

* The results, indicated in this catalogue are provides as example. They may not be obtained due to differences in cutting conditions and environmental conditions during measurement.



Standard / Optional Specifications

● Standard ○ Optional △: Pre-discussion is required X Not applicable

Basic information

Basic Structure
Cutting
Performance

Various options are available to satisfy the customers' requirements.

Detailed Information

Options
Applications
Capacity Diagram
Specifications

Customer Support Service

NO.	Description	PUMA 2100(L) / 2600(L)						PUMA 3100 Std./L			PUMA 3100 XL/UL		
		2-axis Std.	M	S	MS	Y	SY	2-axis Std.	M	Y	2-axis Std.	M	Y
1	Special chucks	△	△	△	△	△	△	△	△	△	△	△	
2	Soft jaws	●	●	●	●	●	●	●	●	●	●	●	
3	Dual pressure chucking	○	○	○	○	○	○	○	○	○	○	○	
4	Hydraulic chuck pressure switch	○	○	○	○	○	○	○	○	○	○	○	
5	Chuck clamp confirmation	○	○	○	○	○	○	○	○	○	○	○	
6	Tail stock center : Live center	●	●	X	X	●	X	●	●	●	X	X	
7	Tail stock center : Dead center	○	○	X	X	○	X	○	○	○	●	●	
8	Tail stock : Manual	●	●	X	X	●	X	●	●	●	X	X	
9	Tail stock : Programmable	○	○	X	X	○	X	○	○	○	●	●	
10	Tail stock : Servo driven	○	○	X	X	○	X	○	○	○	X	X	
11	Automatic quill advance & retract	○	○	X	X	○	X	○	○	○	○	○	
12	Rotary tool holder	X	●	X	●	●	●	X	●	●	X	●	
13	Tool setter : Manual	○	○	○	○	○	○	○	○	○	○	○	
14	Tool setter : Automatic_electric	○	○	○	○	○	○	○	○	○	○	○	
15	Auto workpiece measurement	○	○	○	○	○	○	○	○	○	○	○	
16	Linear scale (X-axis)	○	○	○	○	○	○	○	○	○	○	○	
17	Linear scale (Z-axis)	○	○	○	○	○	○	○	○	○	○	○	
18	Linear scale (Y-axis)	X	X	X	X	○	○	X	X	○	X	○	
19	Feedback system : Absolute position encoder	●	●	●	●	●	●	●	●	●	●	●	
20	Bar feeder interface	○	○	○	○	○	○	○	○	○	○	○	
21	Bar puller	△	△	△	△	△	△	△	△	△	X	X	
22	Workpiece ejector	X	X	○	○	X	○	X	X	X	X	X	
23	Parts catcher with box	○	○	○	○	○	○	△	△	△	X	X	
24	Parts catcher with conveyor	○	○	○	○	○	○	△	△	△	X	X	
25	Workpiece cut off confirmation	X	X	○	○	X	○	X	X	X	X	X	
26	Automatic front door : with safety device	○	○	○	○	○	○	○	○	○	○	○	
27	Chip conveyor type : Right side	○	○	○	○	○	○	○	○	○	○	○	
28	Chip conveyor type : Rear side *1	○	○	○	○	○	○	○	○	○	X	X	
29	Chip bucket	○	○	○	○	○	○	○	○	○	○	○	
30	TSC for main / left spindle	○	○	○	○	○	○	○	○	○	○	○	
31	Oil skimmer	○	○	○	○	○	○	○	○	○	○	○	
32	Coolant level switch	○	○	○	○	○	○	○	○	○	○	○	
33	Coolant chiller	○	○	○	○	○	○	○	○	○	○	○	
34	Oil mist collector	○	○	○	○	○	○	○	○	○	○	○	
35	Coolant blower	○	○	○	○	○	○	○	○	○	○	○	
36	Air blower	○	○	○	○	○	○	○	○	○	○	○	
37	Air gun	○	○	○	○	○	○	○	○	○	○	○	
38	Signal tower (yellow, red, green)	○	○	○	○	○	○	○	○	○	○	○	
39	Gantry loader	△	△	△	△	△	△	△	△	△	△	△	
40	V-stand for shaft workpiece	○	○	X	X	○	X	○	○	○	X	X	

*1 : PUMA 2100/L, PUMA 2600, PUMA 3100 only

Steady rest

○ Optional X Not applicable

Steady Rest		PUMA 2100		PUMA 2600		PUMA 3100	
		Std.	L	Std.	L	Std. /L	XL/UL
Type	Hydraulic	○	○	○	○	○	○
	Programmable	○	○	○	○	○	○
	Servo driven*1	X	X	X	X	X	○
Size	SLU-1	○	○	○	○	X	X
	SLU-2	○	○	○	○	○	○
	SLU-B3.1	X	○	○	○	X	X
	SLU-3.1	X	X	X	X	○	○
	SLU-3.2	X	X	X	X	X	○
	SLU-4	X	X	X	X	X	○*2
	SLU-B4	X	X	X	X	X	○

*1 : Rack & Pinion type.

*2 : SLU-4 is not available in servo driven type.

* Recommend using coolant chiller

High pressure coolant

Model		PUMA 2100 / 2600 / 3100	
		60Hz	50Hz
Standard	1.5 bar	0.4 kW x 0.15 MPa x 40 L/min	0.4 kW x 0.15 MPa x 40 L/min
	5 bar	0.9 kW x 0.45 MPa x 30 L/min	0.9 kW x 0.30 MPa x 30 L/min
	7 bar	1.5 kW x 0.7 MPa x 30 L/min	1.5 kW x 0.5 MPa x 30 L/min
	10 bar*	2.2 kW x 1.0 MPa x 30 L/min	2.2 kW x 0.7 MPa x 30 L/min
	15 bar*	3.7 kW x 1.45 MPa x 30 L/min	4.0 kW x 2.8 MPa x 20 L/min
Special option	28 bar*	4.0 kW x 2.8 MPa x 20 L/min	4.0 kW x 1.95 MPa x 20 L/min
	70 bar*	5.5 kW x 7.0 MPa x 30 L/min	5.5 kW x 7.0 MPa x 26 L/min

Peripheral equipments

Oil skimmer option



The oil skimmer keeps coolant and lubricant isolated from each other for extending lifecycle of coolant.

Tool setter option



The tool setter facilitates setting of tools, and fast and precise length compensation of abraded tool.

Part catcher option



The part catcher automatically accepts parts completed of machining, and ejects them out of the system.

Coolant chiller option

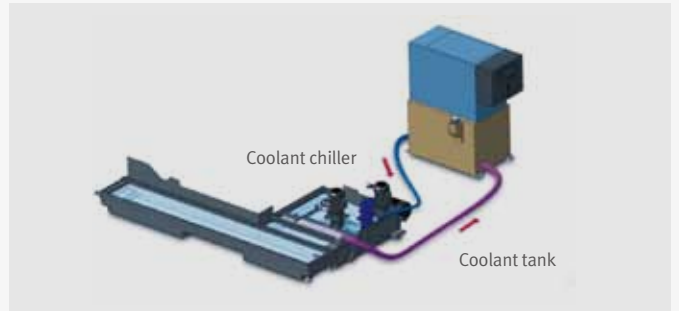

Detachable coolant chiller is recommended to keep thermal error minimal and get higher machining precision.

Mist collector option



The mist collector absorbs airborne oil vapor and fine dusts in the system to improve working environment.

Collet chuck option

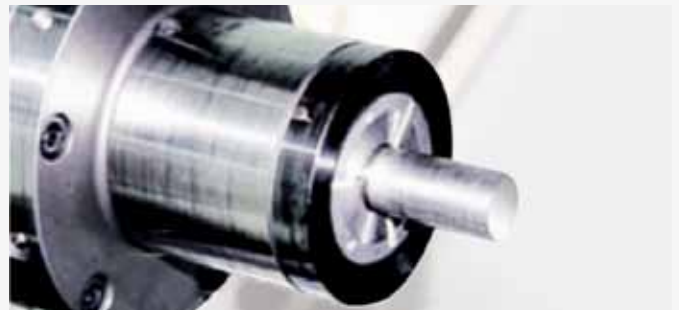

The collet chuck is ideal for loading workpiece of small diameter and light weight.

Coolant Blower option



Signal tower option





Basic information

- Basic Structure
- Cutting
- Performance

Apply Fanuc CNC on the Doosan machine to fulfill best performance and productivity.

Detailed Information

- Options
- Applications
- Capacity Diagram
- Specifications

Customer Support Service

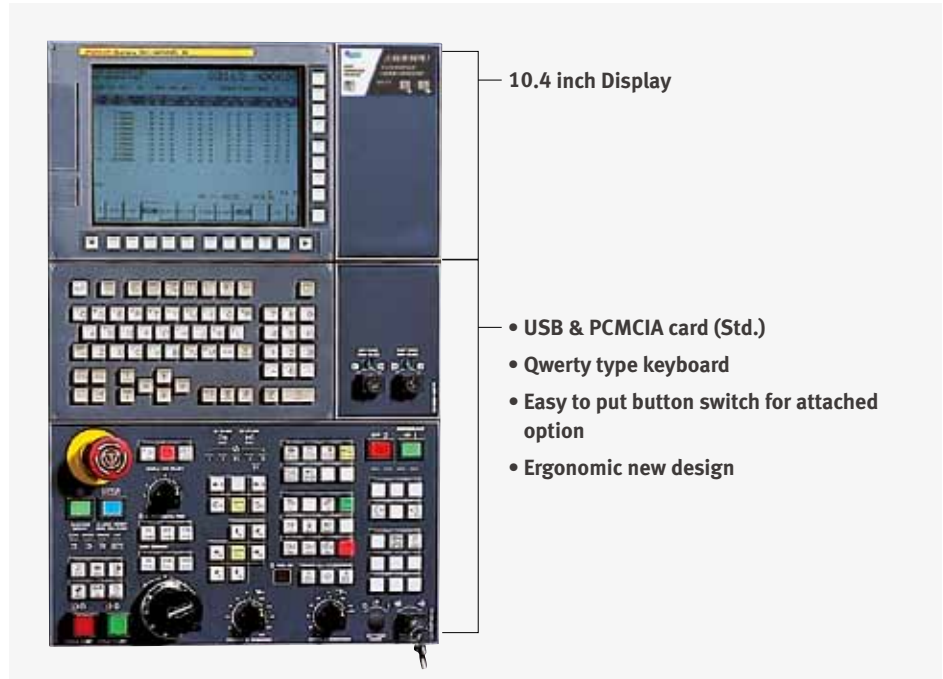

EZ-Guide i

Using the DOOSAN EZ-Guide i, users can create a cutting program for any desired shape, including patterns, by entering figures only.

Example programming

Cutting shape

↓

EZ-Guide i screen

Enter the dimensions of the shape.

Automatic creation of cutting program

```

O7000 (SAMPLE PROGRAM) ;
...
M3 S1500 ;
G0 X50. Y125. ;
G0 Z30. ;
G1040 T0.5 J3. H0.2 K0.5 ... ;
G1020 H120. V50. U37. W68. ... ;
G0 Z80. ;
M5 ;
                    
```

A cutting program is automatically created with the entered values.

Improve productivity

Reduced non-cutting cycle time

10 %

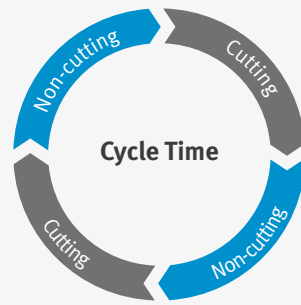

Non-cutting time during machining process is dramatically reduced to guarantee the highest productivity.

Easy operation package

G code / M code



G code / M code help function provides code number and description to view.

Calculator



Calculator function provides a variety of calculations which are arithmetic, hole, arc, machining condition.

Turret recovery



Screen with recovery information about turret malfunction.

Operation rate



Function allows users to easily keep track of machine operating hours and the number of completed parts.

Tool load monitoring



This function detects overload on tools, caused by wear and damage, and triggers an alarm to minimize damage.

Tail stock thrust force setting option

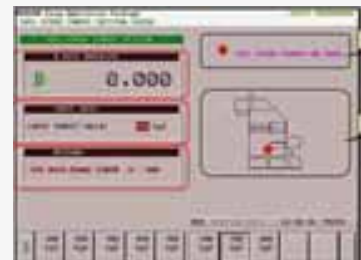

This function allows users to easily setup tailstock thrust force on the screen.

Spindle power-torque diagram

Basic information

Basic Structure
Cutting
Performance

Detailed Information

Options
Applications
Capacity Diagram
Specifications

Customer Support Service

PUMA 2100 series

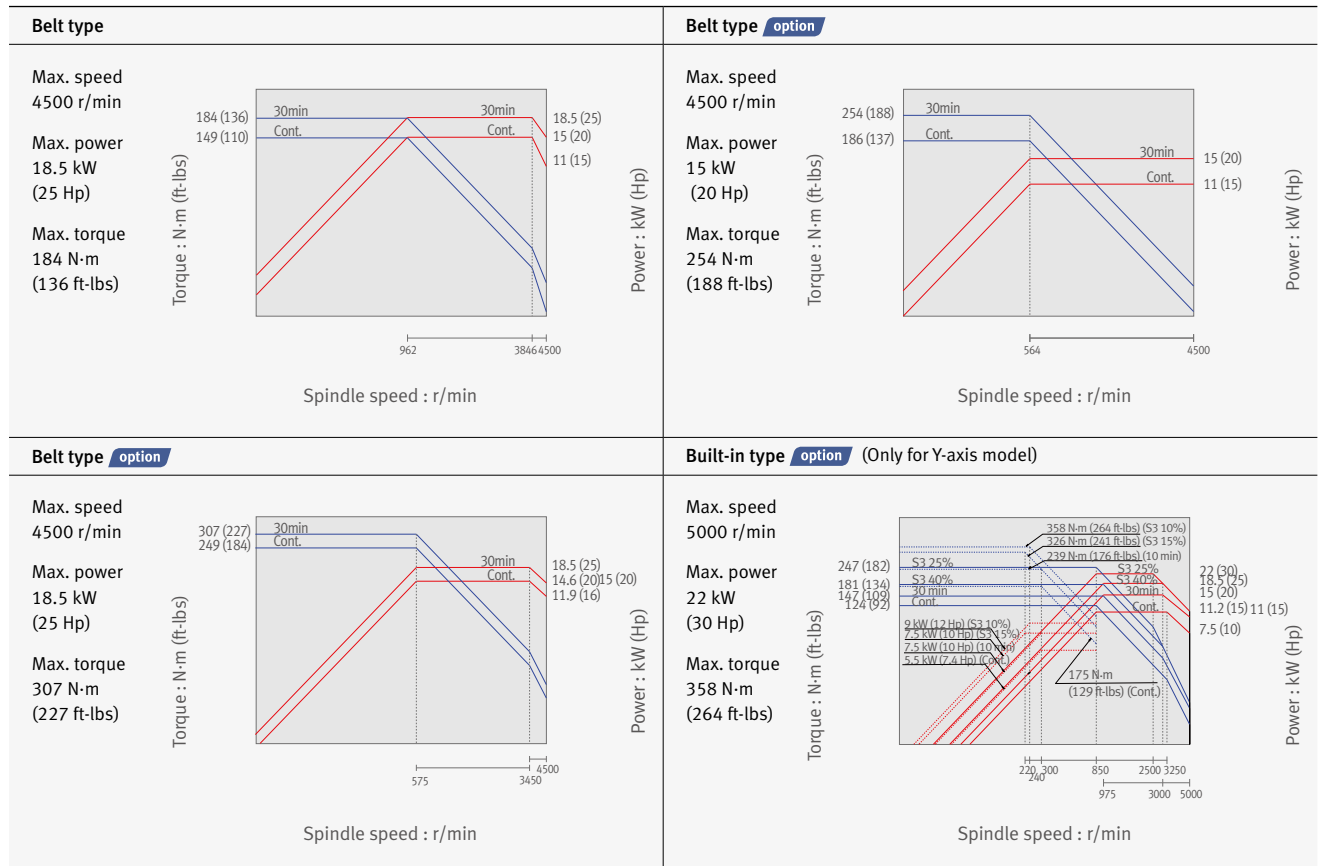

PUMA 2600 series

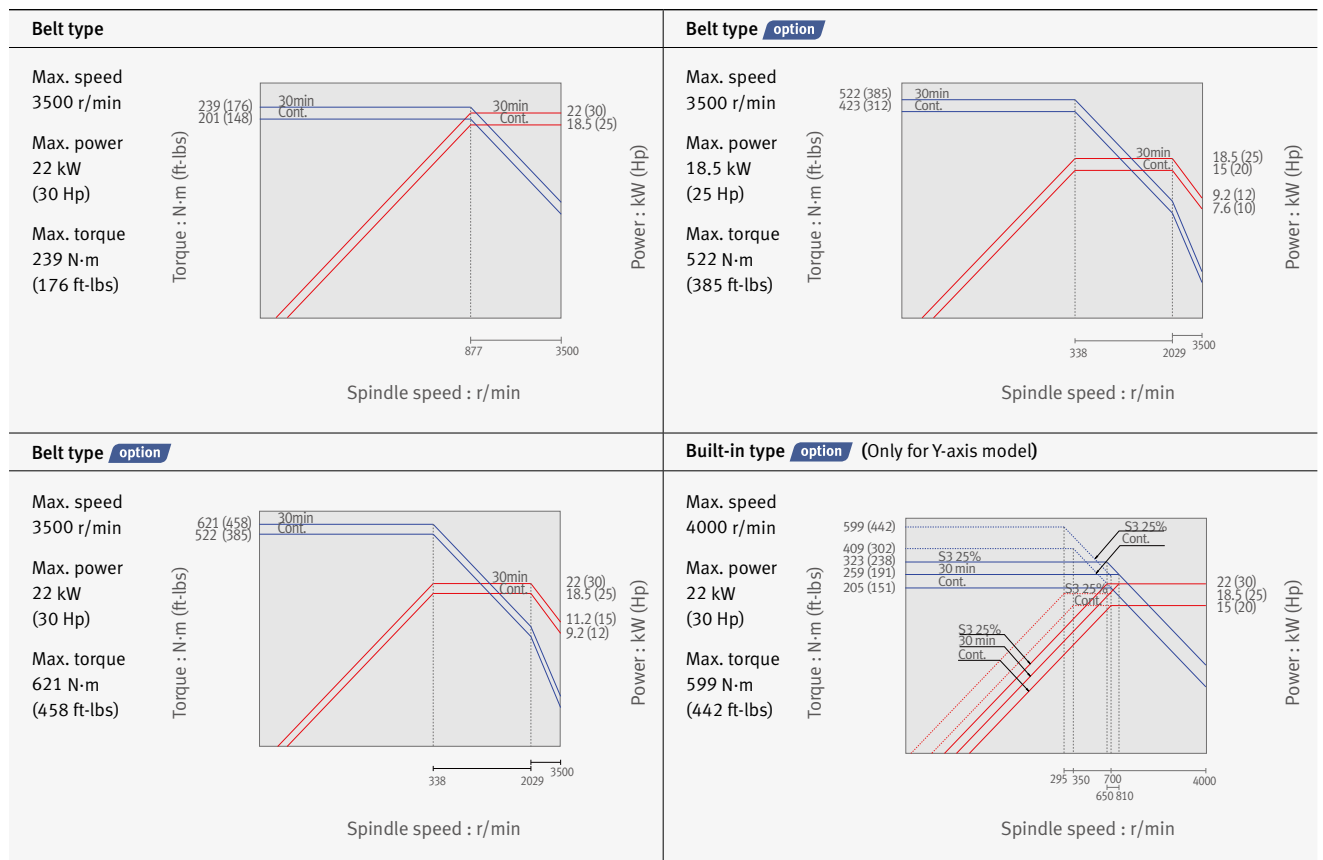

Spindle power-torque diagram

PUMA 2600 / 500, PUMA 2600M / 500

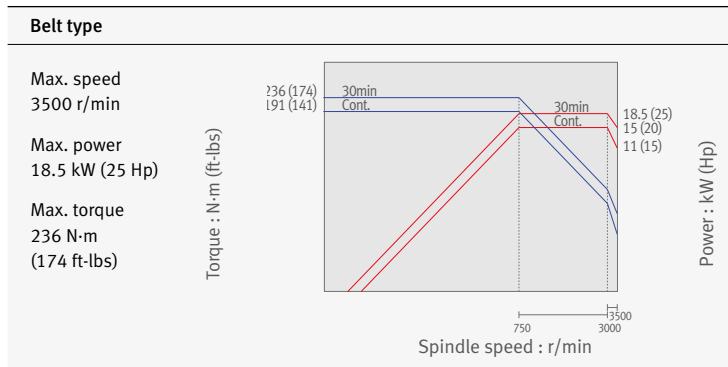

PUMA 2600B / 3100 series

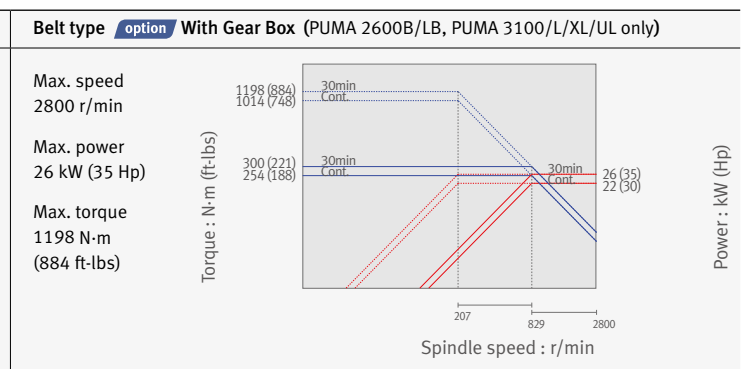
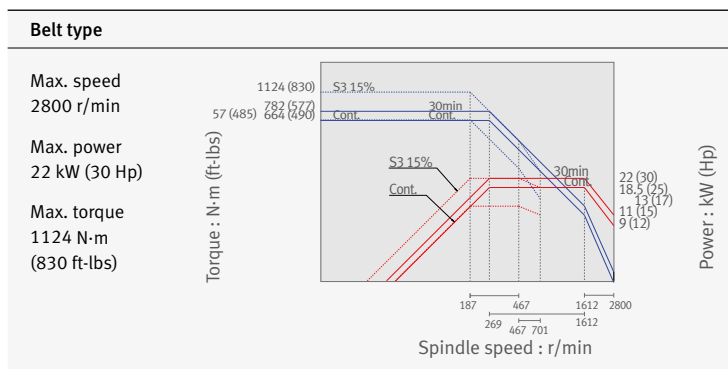

PUMA 3100 series

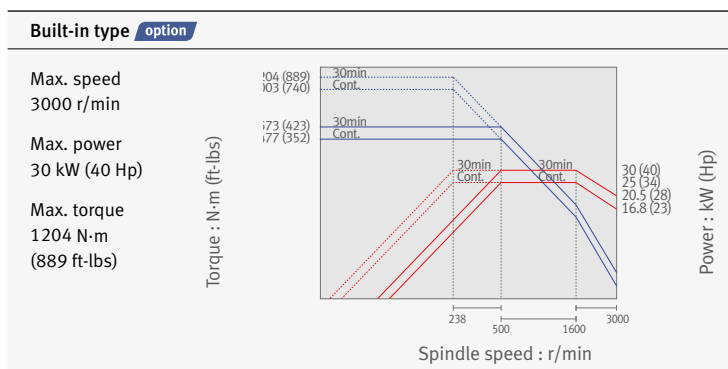

PUMA 3100 XL/UL

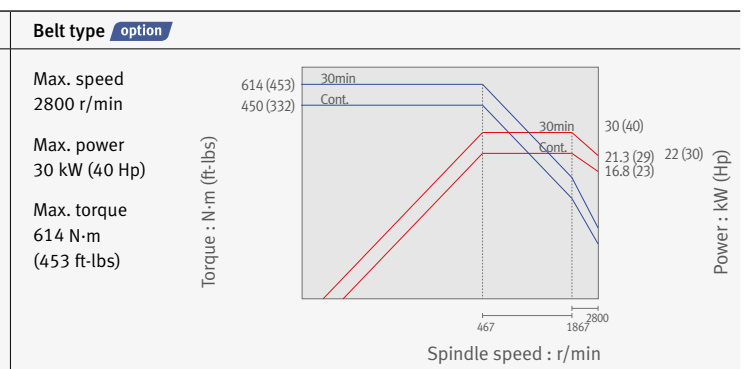

Sub spindle power-torque diagram

PUMA 2100 / 2600

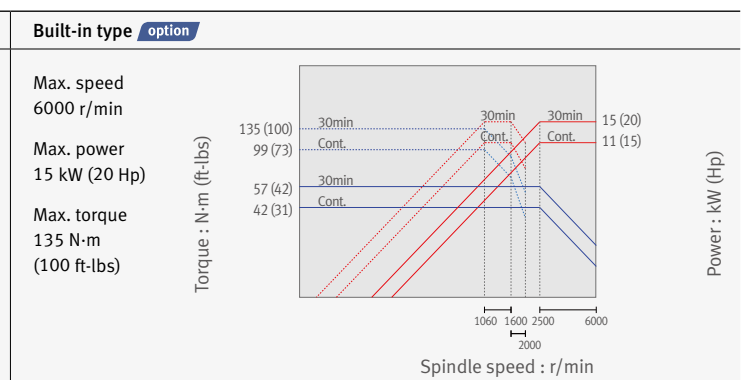
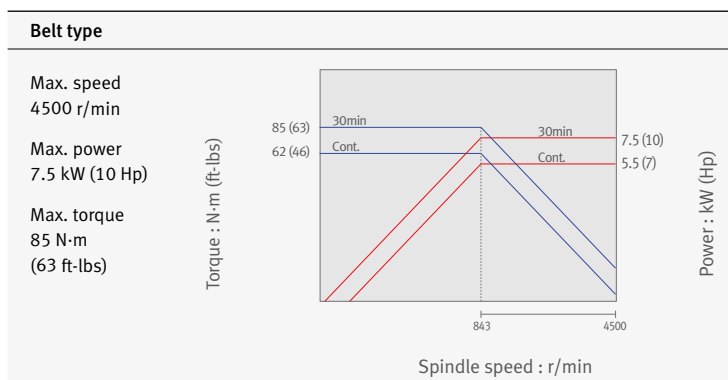

External Dimensions

Basic information

- Basic Structure
- Cutting
- Performance

Detailed Information

- Options
- Applications
- Capacity Diagram
- Specifications

Customer Support Service

PUMA 2100 / 2600

Unit: mm (inch)

Top view

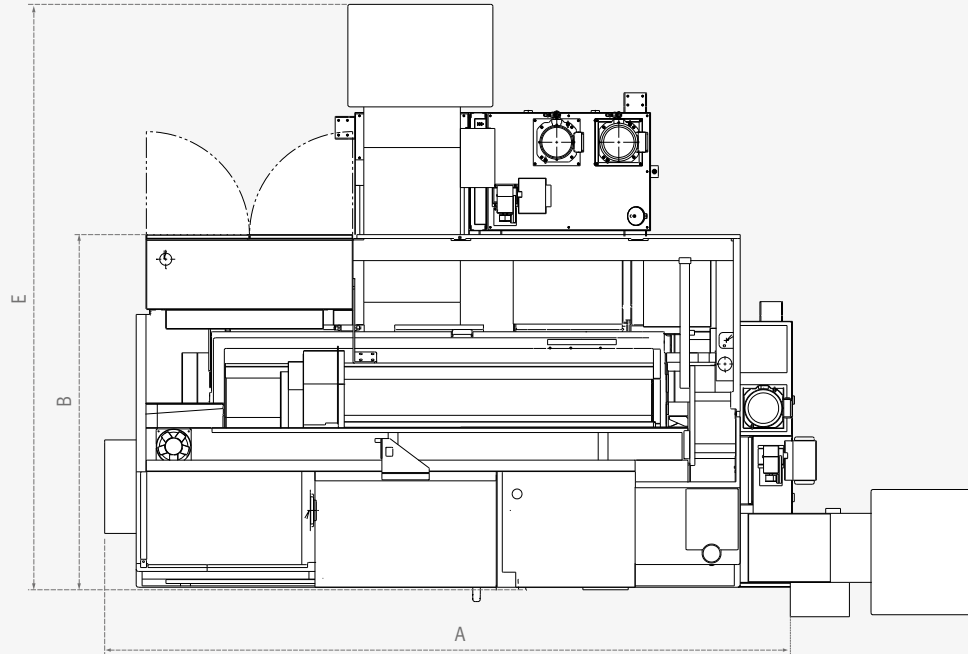

Front view

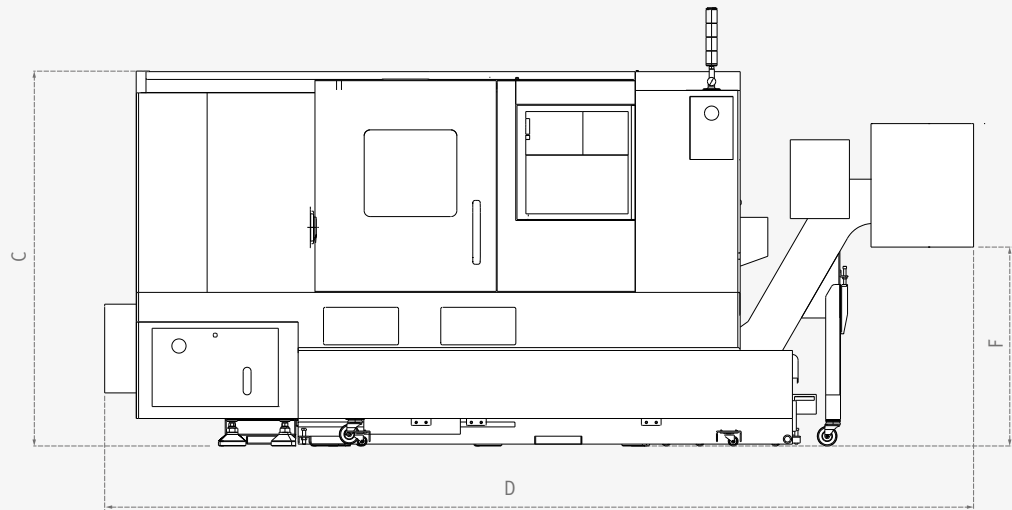

Model	A (Length)	B (Width)	C (Height)	D (Length with side chip conveyor)	E (Width with rear chip conveyor)	F (Height of ground to chip outlet)
PUMA 2100	3415 (134.4)	1863 (73.3)	1900 [2163] (74.8 [85.2])	4190 (165.0)	3032 (119.4)	1010 (39.8)
PUMA 2100L	3530 (139.0)	1863 (73.3)	1900 [2163] (74.8 [85.2])	4410 (173.6)	3032 (119.4)	1010 (39.8)
PUMA 2600/500	3415 (134.4)	1863 (73.3)	1900 (74.8)	4260 (167.7)	3032 (119.4)	1010 (39.8)
PUMA 2600	3600 (141.7)	1863 (73.3)	1900 [2163] (74.8 [85.2])	4480 (176.4)	3032 (119.4)	1010 (39.8)
PUMA 2600L	4335 (170.7)	1965 (77.4)	1900 [2163] (74.8 [85.2])	5389 (212.2)	-	1010 (39.8)
PUMA 2600B	3873 (152.5)	1863 (73.3)	1900 (74.8)	4753 (187.1)	3032 (119.4)	1010 (39.8)
PUMA 2600LB	4438 (174.7)	1965 (77.4)	1900 (74.8)	5492 (216.2)	-	1010 (39.8)

External Dimensions

PUMA 3100XL

Unit: mm (inch)

Top view

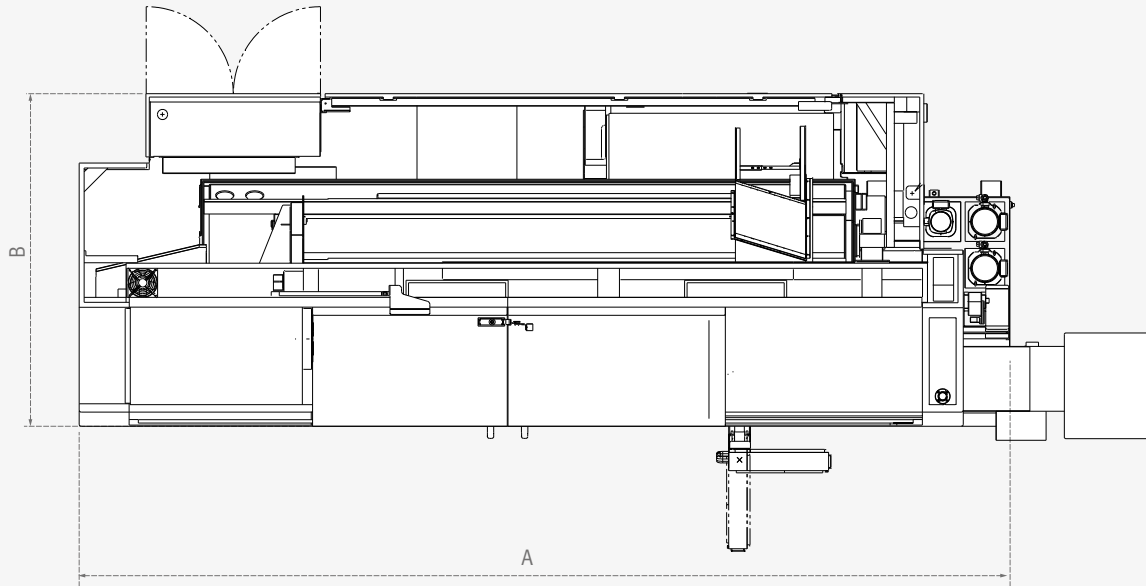

Front view

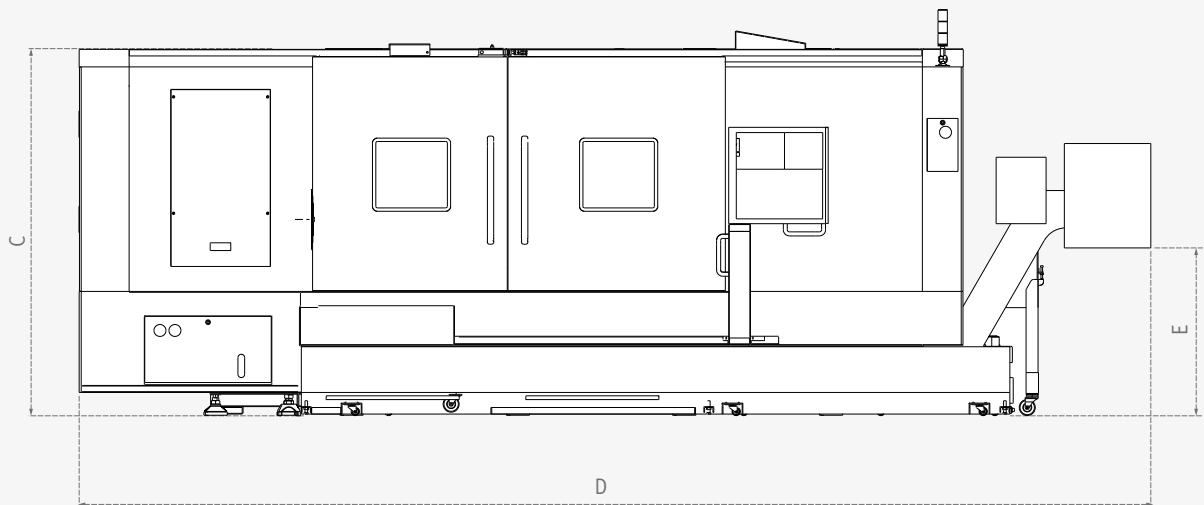

Model	A (Length)	B (Width)	C (Height)	D (Length with side chip conveyor)	E (Height of ground to chip outlet)
PUMA 3100	3908 (153.9)	1978 (77.9)	2010 [2315] (79.1 [91.1])	4819 (189.7)	1010 (39.8)
PUMA 3100L	4527 (178.2)	2067 (81.4)	2010 [2315] (79.1 [91.1])	5599 (220.4)	1010 (39.8)
PUMA 3100XL	5615 (221.1)	2280 (89.8)	2315 (91.1)	6443 (253.7)	1010 (39.8)
PUMA 3100UL	6585 (259.3)	2280 (89.8)	2315 (91.1)	7670 (302.0)	1010 (39.8)

Basic information

Basic Structure
Cutting
Performance

Detailed Information

Options
Applications
Capacity Diagram
Specifications

Customer Support Service

PUMA 2100 series

Description		Unit	PUMA 2100/L	PUMA 2100M/LM	PUMA 2100MS/LMS	PUMA 2100S/LS
Capacity	Swing over bed	mm (inch)	780 (30.7)			
	Swing over front door	mm (inch)	680 (26.8)			
	Swing over saddle*	mm (inch)	630 (24.8)			
	Recom. Turning diameter	mm (inch)	210 (8.3)			
	Max. turning diameter	mm (inch)	481 (18.9)	406 (16.0)		481 (18.9)
	Max. turning length	mm (inch)	545 / 785 (21.5 / 30.9)	520 / 760 (20.5 / 29.9)		545 / 785 (21.5 / 30.9)
	Bar working diameter	mm (inch)	65 (2.6)			
Travels	Travel distance	X-axis	mm (inch)	260 (10.2)		
		Z-axis	mm (inch)	590 / 830 (23.2 / 32.7)		
		Y-axis	mm (inch)	-		
		B-axis	mm (inch)	-	590 / 830 (23.2 / 32.7)	
Feedrates	Rapid traverse	X-axis	m/min (ipm)	30 (1181.1)		
		Z-axis	m/min (ipm)	30 (1181.1)		
		Y-axis	m/min (ipm)	-		
		B-axis	m/min (ipm)	-	30 (1181.1)	
Spindle	Spindle speed (Belt Type)	r/min	4500			
	Spindle speed (Built-in Type)	r/min	-			
	Spindle nose		ASA A2#6			
	Spindle bearing diameter (Front)	mm (inch)	120 (4.7)			
	Spindle through hole diameter	mm (inch)	76 (3.0)			
	Min. spindle indexing angle (C-axis)	deg	-	0.001		
Turret	No. of tool stations	st	12	12 {24}*		12
	OD tool size	mm (inch)	25 (1.0)	25 {20} (1.0 {0.8})*		25 (1.0)
	Boring bar diameter	mm (inch)	50 (2.0)	40 {32} (1.6 {1.3})*		50 (2.0)
	Indexing time (1st swivel time)	s	0.15			
	Rotary tool spindle speed	r/min	-	5000		-
Tail stock	Quill diameter	mm (inch)	80 (3.1)		-	
	Quill bore taper (Live)		MT#4		-	
	Compressed air supply	mm (inch)	80 (3.1)		-	
Sub-spindle	Spindle speed (Belt [Built-in])	r/min	-	4500		
	Spindle nose		-	ASA A2-5		
	Spindle bearing diameter (Front)	mm (inch)	-	90 (3.5)		
	Spindle through hole diameter	mm (inch)	-	62 (2.4)		
	Min. spindle indexing angle (C-axis)	deg	-	0.001		
Motors	Main spindle motor	kW (Hp)	18.5 / 15 (25 / 20)			
	Sub spindle motor	kW (Hp)	-	7.5 / 5.5 (10 / 7)		
	Rotary tool spindle motor	kW (Hp)	-	5.5 (7)		-
	Coolant pump motor	kW (Hp)	0.4 (0)			
Power source	Electric power supply (Rated capacity)	kVA	35.63	38.41	45.63	42.85
Machine size	Machine height	mm (inch)	1900 (74.8)			
	Machine dimension	length	mm (inch)	3310 / 3530 (130.3 / 139.0)		
		width	mm (inch)	1863 (73.3)		
	Machine weight	kg (lb)	4850 / 5350 (10692.3 / 11794.6)	5000 / 5500 (11023.0 / 12125.2)	5450 / 5950 (12015.0 / 13117.3)	5300 / 5800 (11684.3 / 12786.6)

*{ } : Option

Machine Specifications

PUMA 2100 / 2600 series

Description		Unit	PUMA 2100Y/LY	PUMA 2100SY/LSY	PUMA 2600/L	PUMA 2600M/LM	
Capacity	Swing over bed	mm (inch)	780 (30.7)				
	Swing over front door	mm (inch)	680 (26.8)				
	Swing over saddle*	mm (inch)	630 (24.8)				
	Recom. Turning diameter	mm (inch)	210 (8.3)		255 (10.0)		
	Max. turning diameter	mm (inch)	406 (16.0)		481 (18.9)	376 (14.8)	
	Max. turning length	mm (inch)	520 / 760 (20.5 / 29.9)		790 / 1310 (31.1 / 51.6)	760 / 1280 (29.9 / 50.4)	
	Bar working diameter	mm (inch)	65 (2.6)		76 (3.0)		
Travels	Travel distance	X-axis	mm (inch)	260 (10.2)			
		Z-axis	mm (inch)	590 / 830 (23.2 / 32.7)		830 / 1350 (32.7 / 53.1)	
		Y-axis	mm (inch)	105 (4.1)		-	
		B-axis	mm (inch)	-	590 / 830 (23.2 / 32.7)	-	
Feedrates	Rapid traverse	X-axis	m/min (ipm)	30 (1181.1)			
		Z-axis	m/min (ipm)	30 (1181.1)			
		Y-axis	m/min (ipm)	10 (393.7)		-	
		B-axis	m/min (ipm)	-	30 (1181.1)	-	
Spindle	Spindle speed (Belt Type)	r/min	4500		3500		
	Spindle speed (Built-in Type)	r/min	5000		-		
	Spindle nose		ASA A2#6		ASA A2#8		
	Spindle bearing diameter (Front)	mm (inch)	120 (4.7)		140 (5.5)		
	Spindle through hole diameter	mm (inch)	76 (3.0)		86 (3.4)		
	Min. spindle indexing angle (C-axis)	deg	0.001		-	0.001	
Turret	No. of tool stations	st	12 {24} {16}*		12	12 {24}*	
	OD tool size	mm (inch)	25 {20} {25} (1.0 {0.8} {1.0})*		25 (1.0)	25 {20} (1.0 {0.8})*	
	Boring bar diameter	mm (inch)	40 {32} {32} (1.6 {1.3} {1.3})*		50 (2.0)	50 {40} (2.0 {1.6})*	
	Indexing time (1st swivel time)	s	0.15				
	Rotary tool spindle speed	r/min	5000		-	5000	
Tail stock	Quill diameter	mm (inch)	80 (3.1)	-	100 (3.9)		
	Quill bore taper (Live)		MT#4	-	MT#5		
	Compressed air supply	mm (inch)	80 (3.1)	-	100 (3.9)		
Sub-spindle	Spindle speed (Belt [Built-in])	r/min	-	4500 [6000]		-	
	Spindle nose		-	ASA A2-5		-	
	Spindle bearing diameter (Front)	mm (inch)	-	90		-	
	Spindle through hole diameter	mm (inch)	-	62		-	
	Min. spindle indexing angle (C-axis)	deg	-	0.001		-	
Motors	Main spindle motor	kW (Hp)	18.5 / 15 (25 / 20)		22 / 18.5 (30 / 25)		
	Sub spindle motor	kW (Hp)	-	7.5 / 5.5 (10 / 7)		-	
	Rotary tool spindle motor	kW (Hp)	5.5 (7)		-		
	Coolant pump motor	kW (Hp)	0.4 (0)				
Power source	Electric power supply (Rated capacity)	kVA	41.32	48.54	40.72	43.5	
Machine size	Machine height	mm (inch)	2163 (85.2)		1900 (74.8)		
	Machine dimension	length	mm (inch)	3310 / 3530 (130.3 / 139.0)		3600 / 4335 (141.7 / 170.7)	
		width	mm (inch)	1863 (73.3)		1863 / 1965 (73.3 / 77.4)	
	Machine weight	kg (lb)	5450 / 5950 (12015.0 / 13117.3)	5900 / 6400 (13007.1 / 14109.4)	5400 / 6700 (11904.8 / 14770.8)	5550 / 6850 (12235.5 / 15101.4)	

*{ } : Option

* The specifications and information above-ntioned may be changed without prior notice.

* For more details, please contact Doosan.

Basic information

Basic Structure
Cutting
Performance

Detailed Information

Options
Applications
Capacity Diagram
Specifications

Customer Support Service

PUMA 2600 series

Description		Unit	PUMA 2600MS/LMS	PUMA 2600S/LS	PUMA 2600Y/LY	PUMA 2600SY/LSY	
Capacity	Swing over bed	mm (inch)	780 (30.7)				
	Swing over front door	mm (inch)	680 (26.8)				
	Swing over saddle*	mm (inch)	630 (24.8)				
	Recom. Turning diameter	mm (inch)	255 (10.0)				
	Max. turning diameter	mm (inch)	376 (14.8)	481 (18.9)	376 (14.8)		
	Max. turning length	mm (inch)	760 / 1280 (29.9 / 50.4)	790 / 1310 (31.1 / 51.6)	760 / 1280 (29.9 / 50.4)		
	Bar working diameter	mm (inch)	76 (3.0)				
Travels	Travel distance	X-axis	260 (10.2)				
		Z-axis	830 / 1350 (32.7 / 53.1)				
		Y-axis	-		105 (±52.5) (4.1 (±2.1))		
		B-axis	830 / 1350 (32.7 / 53.1)		-		830 / 1350 (32.7 / 53.1)
Feedrates	Rapid traverse	X-axis	30 (1181.1)				
		Z-axis	30 (1181.1)				
		Y-axis	-		10 (393.7)		
		B-axis	30 (1181.1)		-		30 (1181.1)
Spindle	Spindle speed (Belt Type)	r/min	3500				
	Spindle speed (Built-in Type)	r/min	-		4000		
	Spindle nose		ASA A2#8				
	Spindle bearing diameter (Front)	mm (inch)	140 (5.5)				
	Spindle through hole diameter	mm (inch)	86 (3.4)				
	Min. spindle indexing angle (C-axis)	deg	0.001	-		0.001	
Turret	No. of tool stations	st	12 {24}* (1.0 {0.8})*	12	12 {24}* (1.0 {0.8})*		
	OD tool size	mm (inch)	25 {20} (1.0 {0.8})*	25	25 {20} (1.0 {0.8})*		
	Boring bar diameter	mm (inch)	50 {40} (2.0 {1.6})*	50	50 {40} (2.0 {1.6})*		
	Indexing time (1st swivel time)	s	0.15				
	Rotary tool spindle speed	r/min	5000	-		5000	
Tail stock	Quill diameter	mm (inch)	-		100 (3.9)	-	
	Quill bore taper (Live)		-		MT#5	-	
	Compressed air supply	mm (inch)	-		100 (3.9)	-	
Sub-spindle	Spindle speed (Belt [Built-in])	r/min	4500	-		4500 [6000]	
	Spindle nose		ASA A2-5		-		
	Spindle bearing diameter (Front)	mm (inch)	90 (3.5)	-		90 (3.5)	
	Spindle through hole diameter	mm (inch)	62 (2.4)	-		62 (2.4)	
	Min. spindle indexing angle (C-axis)	deg	0.001	-		0.001	
Motors	Main spindle motor	kW (Hp)	22 / 18.5 (30 / 25)				
	Sub spindle motor	kW (Hp)	7.5 / 5.5 (11 / 7)		-		7.5 / 5.5 (11 / 7)
	Rotary tool spindle motor	kW (Hp)	5.5 {7.5} (7 {10})*	-		5.5 {7.5} (7 {10})*	
	Coolant pump motor	kW (Hp)	0.4 (0.5)				
Power source	Electric power supply (Rated capacity)	kVA	51.65	48.86	46.4	54.55	
Machine size	Machine height	mm (inch)	1900 (74.8)		2163 (85.2)		
	Machine dimension	length	mm (inch)	3600 / 4335 (141.7 / 170.7)		3600 / 4435 (141.7 / 174.6)	
		width	mm (inch)	1863 / 1965 (73.3 / 77.4)			
	Machine weight	kg (lb)	6000 / 7300 (13227.5 / 16093.5)	5850 / 7150 (12896.9 / 15762.8)	6000 / 7300 (13227.5 / 16093.5)	6450 / 7750 (14219.6 / 17085.6)	

*{ } : Option

* The specifications and information above-ntioned may be changed without prior notice.

* For more details, please contact Doosan.

Machine Specifications

PUMA 2600 series

Description		Unit	PUMA 2600/500	PUMA 2600M/500	PUMA 2600B/LB	PUMA 2600MB/LMB	
Capacity	Swing over bed	mm (inch)	780 (30.7)				
	Swing over front door	mm (inch)	680 (26.8)				
	Swing over saddle*	mm (inch)	630 (24.8)				
	Recom. Turning diameter	mm (inch)	255 (10.0)		305 (12.0)		
	Max. turning diameter	mm (inch)	481 (18.9)	376 (14.8)	481 (18.9)	376 (14.8)	
	Max. turning length	mm (inch)	550 (21.7)	520 (20.5)	755 / 1275 (29.7 / 50.2)	725 / 1245 (28.5 / 49.0)	
	Bar working diameter	mm (inch)	65 (2.6)		102 (4.0)		
Travels	Travel distance	X-axis	mm (inch)	260 (10.2)			
		Z-axis	mm (inch)	590 (23.2)	830 / 1350 (32.7 / 53.1)		
		Y-axis	mm (inch)	-			
		B-axis	mm (inch)	-			
Feedrates	Rapid traverse	X-axis	m/min (ipm)	30 (1181.1)			
		Z-axis	m/min (ipm)	30 (1181.1)			
		Y-axis	m/min (ipm)	-			
		B-axis	m/min (ipm)	-			
Spindle	Spindle speed (Belt Type)	r/min	3500		2800		
	Spindle nose		ASA A2-8		A2-11		
	Spindle bearing diameter (Front)	mm (inch)	140 (5.5)		160 (6.3)		
	Spindle through hole diameter	mm (inch)	86 (3.4)		115 (4.5)		
	Min. spindle indexing angle (C-axis)	deg	0.001				
Turret	No. of tool stations	st	12	12 {24}*	12	12 {24}*	
	OD tool size	mm (inch)	25 (1.0)	25 {20} (1.0 {0.8})*	25	25 {20} (1.0 {0.8})*	
	Boring bar diameter	mm (inch)	50 (2.0)	50 {40} (2.0 {1.6})*	50	50 {40} (2.0 {1.6})*	
	Indexing time (1st swivel time)	s	0.15				
	Rotary tool spindle speed	r/min	-	5000	-	5000	
Tail stock	Quill diameter	mm (inch)	100 (3.9)				
	Quill bore taper (Live)		MT#5				
	Compressed air supply	mm (inch)	100 (3.9)				
Sub-spindle	Spindle speed (Belt [Built-in])	r/min	-				
	Spindle nose		-				
	Spindle bearing diameter (Front)	mm (inch)	-				
	Spindle through hole diameter	mm (inch)	-				
	Min. spindle indexing angle (C-axis)	deg	-				
Motors	Main spindle motor	kW (Hp)	18.5 / 15 (25 / 20)		22 / 18.5 (30 / 25)		
	Sub spindle motor	kW (Hp)	-				
	Rotary tool spindle motor	kW (Hp)	-	5.5 (7)	-	5.5 (7)	
	Coolant pump motor	kW (Hp)	0.4 (0)				
Power source	Electric power supply (Rated capacity)	kVA	40.72	44.42	40.72	44.42	
Machine size	Machine height	mm (inch)	1900 (74.8)				
	Machine dimension	length	mm (inch)	3370 (132.7)		3700 {4438} (145.7 {174.7})*	
		width	mm (inch)	1863 (73.3)			
	Machine weight	kg (lb)	4900 (10802.5)	5000 (11023.0)	5500 / 6800 (12125.2 / 14991.2)	5650 / 6950 (12455.9 / 15321.9)	

* { } : Option

* The specifications and information above-ntioned may be changed without prior notice.

* For more details, please contact Doosan.

Basic information

Basic Structure
Cutting
Performance

Detailed Information

Options
Applications
Capacity Diagram
Specifications

Customer Support Service

PUMA 2600 series

Description		Unit	PUMA 2600SB	PUMA 2600MSB	PUMA 2600YB	PUMA 2600SYB
Capacity	Swing over bed	mm (inch)	780 (30.7)			
	Swing over front door	mm (inch)	680 (26.8)			
	Swing over saddle*	mm (inch)	630 (24.8)			
	Recom. Turning diameter	mm (inch)	305 (12.0)			
	Max. turning diameter	mm (inch)	481 (18.9)	376 (14.8)		
	Max. turning length	mm (inch)	755 (29.7)	725 (28.5)		
	Bar working diameter	mm (inch)	102 (4.0)			
	Travels	Travel distance	X-axis	mm (inch)	260 (10.2)	
Z-axis			mm (inch)	830 (32.7)		
Y-axis			mm (inch)	-	105 (4.1)	
B-axis			mm (inch)	830 (32.7)	-	830 (32.7)
Feedrates	Rapid traverse	X-axis	m/min (ipm)	30 (1181.1)		
		Z-axis	m/min (ipm)	30 (1181.1)		
		Y-axis	m/min (ipm)	-	10 (393.7)	
		B-axis	m/min (ipm)	30 (1181.1)	-	30 (1181.1)
Spindle	Spindle speed (Belt Type)	r/min	2800			
	Spindle nose		ASA A2-11			
	Spindle bearing diameter (Front)	mm (inch)	160 (6.3)			
	Spindle through hole diameter	mm (inch)	115 (4.5)			
	Min. spindle indexing angle (C-axis)	deg	-	0.001		
Turret	No. of tool stations	st	12	12 {24}*		
	OD tool size	mm (inch)	25 (1.0)	25 {20} (1.0 {0.8})*		
	Boring bar diameter	mm (inch)	50 (2.0)	50 {40} (2.0 {1.6})*		
	Indexing time (1st swivel time)	s	0.15			
	Rotary tool spindle speed	r/min	-	5000		
Tail stock	Quill diameter	mm (inch)	100 (3.9)			
	Quill bore taper (Live)		MT#5			
	Compressed air supply	mm (inch)	100 (3.9)			
Sub-spindle	Spindle speed (Belt [Built-in])	r/min	4500	-	4500	
	Spindle nose		ASA A2#5	-	ASA A2#5	
	Spindle bearing diameter (Front)	mm (inch)	90 (3.5)	-	90 (3.5)	
	Spindle through hole diameter	mm (inch)	62 (2.4)	-	62 (2.4)	
	Min. spindle indexing angle (C-axis)	deg	0.001	-	0.001	
Motors	Main spindle motor	kW (Hp)	22 / 18.5 (30 / 25)			
	Sub spindle motor	kW (Hp)	7.5 / 5.5 (10 / 7)	-	7.5 / 5.5 (10 / 7)	
	Rotary tool spindle motor	kW (Hp)	-	5.5 (7)		
	Coolant pump motor	kW (Hp)	0.4 (0)			
Power source	Electric power supply (Rated capacity)	kVA	48.86	46.40	54.55	
Machine size	Machine height	mm (inch)	1900 (74.8)	2163 (85.2)		
	Machine dimension	length	mm (inch)	3700 (145.7)		
		width	mm (inch)	1863 (73.3)		
	Machine weight	kg (lb)	5950 (13117.3)	6100 (13448.0)	6100 (13448.0)	6550 (14440.1)

* { } : Option

* The specifications and information above-ntioned may be changed without prior notice.

* For more details, please contact Doosan.

Machine Specifications

PUMA 3100 series

Description		Unit	PUMA 3100 /L/XL/UL	PUMA 3100 M/LM/XLM/ULM	PUMA 3100 Y/LY/XLY/ULY
Capacity	Swing over bed	mm (inch)	850 (33.5)		
	Swing over front door	mm (inch)	720 (28.3)** / 850 (33.5)***		
	Swing over saddle*	mm (inch)	670 (26.4)		
	Recom. Turning diameter	mm (inch)	305 (12.0)		
	Max. turning diameter	mm (inch)	525 (20.7)	420 (16.5)	
	Max. turning length	mm (inch)	790 / 1310 / 2150 / 3150 (31.1 / 51.6 / 84.6 / 124.0)	765 / 1285 / 2125 / 3125 (30.1 / 50.6 / 83.7 / 123.0)	
	Bar working diameter	mm (inch)	102 (4.0)		
Travels	Travel distance	X-axis	mm (inch)	293 {30.5+262.5} (11.5 {1.2+10.3})*	293 {83+210} (11.5 {3.3+8.3})*
		Z-axis	mm (inch)	830 / 1350 / 2190 / 3190(32.7 / 53.1 / 86.2 / 125.6)	
		Y-axis	mm (inch)	-	130 (±65) (5.1 (±2.6))
		B-axis	mm (inch)	-	
Feedrates	Rapid traverse	X-axis	m/min (ipm)	30 (1181.1)	
		Z-axis	m/min (ipm)	30 / 30 / 30 / 26 (1181.1 / 1181.1 / 1181.1 / 1023.6)	
		Y-axis	m/min (ipm)	-	10 (393.7)
		B-axis	m/min (ipm)	-	
Spindle	Spindle speed (Belt Type)	r/min	2800		
	Spindle speed (Built-in Type)	r/min	3000		
	Spindle nose		ASA A2#11		
	Spindle bearing diameter (Front)	mm (inch)	160 (6.3)		
	Spindle through hole diameter	mm (inch)	115 (4.5)		
	Min. spindle indexing angle (C-axis)	deg	0.001		
Turret	No. of tool stations	st	10	12	
	OD tool size	mm (inch)	25 (1.0)		
	Boring bar diameter	mm (inch)	50 (2.0)		
	Indexing time (1st swivel time)	s	0.15		
	Rotary tool spindle speed	r/min	-	5000	
Tail stock	Quill diameter	mm (inch)	100 / 100 / 120 / 120 (3.9 / 3.9 / 4.7 / 4.7)		
	Quill bore taper (Live)		MT#5		
	Compressed air supply	mm (inch)	100 / 100 / 120 / 120 (3.9 / 3.9 / 4.7 / 4.7)		
Sub-spindle	Spindle speed (Belt [Built-in])	r/min	-		
	Spindle nose		-		
	Spindle bearing diameter (Front)	mm (inch)	-		
	Spindle through hole diameter	mm (inch)	-		
	Min. spindle indexing angle (C-axis)	deg	-		
Motors	Main spindle motor	kW (Hp)	22 / 18.5 (30 / 25)		
	Sub spindle motor	kW (Hp)	-		
	Rotary tool spindle motor	kW (Hp)	7.5 / 5.5 (7 / 10)		
	Coolant pump motor	kW (Hp)	0.4		
Power source	Electric power supply (Rated capacity)	kVA	41.64 / 41.64 / 42.83 / 42.83	44.42 / 44.42 / 45.61 / 45.61	46.40 / 46.40 / 47.59 / 47.59
Machine size	Machine height	mm (inch)	2020 / 2020 / 2315 / 2315 (79.5 / 79.5 / 91.1 / 91.1)		2315 (91.1)
	Machine dimension	length	mm (inch)	3910 / 4530 / 5615 / 5685 (153.9 / 178.3 / 221.1 / 223.8)	
		width	mm (inch)	2002 / 2105 / 2280 / 2280 (78.8 / 82.9 / 89.8 / 89.8)	
Machine weight	kg (lb)	5850 / 7350 / 10150 / 11650 (12896.9 / 16203.7 / 22376.6 / 23683.5)	6000 / 7500 / 10300 / 11800 (13227.5 / 16534.4 / 22707.3 / 26014.4)	6500 / 8000 / 10800 / 12300 (14329.8 / 17636.7 / 23809.6 / 27116.5)	

*{ } : Option

* The specifications and information above-mentioned may be changed without prior notice.

** : PUMA 3100/M/L/LM/Y/LY

*** : PUMA 3100XL/UL/XLM/ULM/XLY/ULY

* For more details, please contact Doosan.

NC Unit Specifications

● Standard ○ Optional X Not applicable

Basic information

Basic Structure
Cutting
Performance

Detailed Information

Options
Applications
Capacity Diagram
Specifications

Customer Support Service



NO.	Division	Item	Spec.	DOOSAN-FANUC i						Fanuc 31i	
				2 axis	M	S	MS	Y	SY	Y	SY
1	Controlled axis	Controlled axes		X, Z	X, Z, C	X, Z, B	X, Z, C, B	X, Z, C, Y	X, Z, C1, Y, C2, B	X, Z, C, Y	X, Z, C1, Y, C2, B
2		Cs contouring control		X	●	X	●	●	●	●	●
3		Synchronous / Composite control (C1 & C2 Synchro Control)		X	X	X	●	X	●	X	●
4		Torque control		●	●	●	●	●	●	●	●
5		HRV2 control		●	●	●	●	●	●	●	●
6		Inch / metric conversion		●	●	●	●	●	●	●	●
7		Stored limit check before move		●	●	●	●	●	●	○	○
8		Chamfering on / off		●	●	●	●	●	●	●	●
9		Unexpected disturbance torque detection function		●	●	●	●	●	●	●	●
10		Position switch		●	●	●	●	●	●	●	●
11	Operation	DNC operation	Included in RS232C interface.	●	●	●	●	●	●	●	●
12		DNC operation with memory card		●	●	●	●	●	●	●	●
13		Tool retract and recover		X	X	X	X	X	X	○	○
14		Dry run		●	●	●	●	●	●	●	●
15		Single block		●	●	●	●	●	●	●	●
16		Handle interruption		○	○	○	○	○	○	○	○
17		Incremental feed	x1, x10, x100	●	●	●	●	●	●	●	●
18		Manual handle retrace		○	○	○	○	○	○	○	○
19		Active block cancel		X	X	X	X	X	X	○	○
20		Interpolation functions	Nano interpolation		●	●	●	●	●	●	●
21	Linear interpolation			●	●	●	●	●	●	●	●
22	Circular interpolation			●	●	●	●	●	●	●	●
23	Polar coordinate interpolation			X	●	X	●	●	●	●	●
24	Cylindrical interpolation			X	●	X	●	●	●	●	●
25	Helical interpolation			X	○	X	○	●	●	●	●
26	Thread cutting, synchronous cutting			●	●	●	●	●	●	●	●
27	Multi threading			●	●	●	●	●	●	●	●
28	Thread cutting retract			●	●	●	●	●	●	●	●
29	Continuous threading			●	●	●	●	●	●	●	●
30	Variable lead thread cutting			●	●	●	●	●	●	○	○
31	Circular thread cutting			X	X	X	X	X	X	○	○
32	Polygon machining with two spindles			X	●	X	●	●	●	○	○
33	High-speed skip		Input signal is 8 points.	○	○	○	○	○	○	○	○
34	2nd reference position return		G30	●	●	●	●	●	●	●	●
35	3rd / 4th reference position return			●	●	●	●	●	●	○	○
36	Feed function		Override cancel		●	●	●	●	●	●	●
37		AI contour control I		○	○	○	○	○	○	●	●
38		AI contour control II		○	○	○	○	○	○	○	○
39	Rapid traverse block overlap		●	●	●	●	●	●	●	●	
40	Program input	Optional block skip	9 pieces	●	●	●	●	●	●	●	●
41		Absolute / incremental programming	Combined use in the same block	●	●	●	●	●	●	●	●
42		Diameter / Radius programming		●	●	●	●	●	●	●	●
43		Automatic coordinate system setting		●	●	●	●	●	●	●	●
44		Workpiece coordinate system	G52 - G59	●	●	●	●	●	●	●	●
45		Workpiece coordinate system preset		●	●	●	●	●	●	○	○
46		Addition of workpiece coordinate system	48 pairs	X	X	X	X	X	X	○	○
47	Direct drawing dimension programming		●	●	●	●	●	●	●	●	

● Standard ○ Optional X Not applicable

NO.	Division	Item	Spec.	DOOSAN-FANUC i						Fanuc 31i	
				2 axis	M	S	MS	Y	SY	Y	SY
48	Program input	G code system	A	●	●	●	●	●	●	●	●
49		G code system	B / C	●	●	●	●	●	●	●	●
50		Chamfering / Corner R		●	●	●	●	●	●	○	○
51		Custom macro		●	●	●	●	●	●	●	●
52		Addition of custom macro common variables	#100 - #199, #500 - #999	●	●	●	●	●	●	○	○
53		Interruption type custom macro		●	●	●	●	●	●	○	○
54		Canned cycle		●	●	●	●	●	●	●	●
55		Multiple repetitive cycles	G70~G76	●	●	●	●	●	●	●	●
56		Multiple repetitive cycles II	Pocket profile	●	●	●	●	●	●	●	●
57		Canned cycle for drilling		●	●	●	●	●	●	●	●
58		Automatic corner override		X	X	X	X	X	X	○	○
59		Coordinate system shift		●	●	●	●	●	●	●	●
60		Direct input of coordinate system shift		●	●	●	●	●	●	●	●
61		Pattern data input		●	●	●	●	●	●	○	○
62	Operation	EZ Guidei (Conversational Programming Solution)	●	●	●	●	●	●	●	●	
63	Guidance Function	EZ Operation package	●	●	●	●	●	●	●	●	
64	Auxiliary / Spindle speed function	Constant surface speed control	●	●	●	●	●	●	●	●	
65		Spindle override	0 - 150%	●	●	●	●	●	●	●	
66		Spindle orientation		●	●	●	●	●	●	●	
67		Spindle synchronous control		X	X	●	●	X	X	●	
68		Rigid tap		●	●	●	●	●	●	●	
69	Arbitrary speed threading		○	○	○	○	○	○	○	○	
70	Tool function / Tool compensation	Tool offset pairs	32-pairs	X	X	X	X	X	X	●	●
71			64-pairs	●	●	●	X	●	X	○	○
72			99-pairs	○	○	○	X	○	X	○	○
73			128-pairs	X	X	X	●	X	●	X	X
74			200-pairs	X	X	X	○	X	○	○	○
75			400-pairs	X	X	X	X	X	X	○	○
76		Tool offset		●	●	●	●	●	●	●	
77		Tool radius/Tool nose radius compensation		●	●	●	●	●	●	●	
78		Tool geometry / wear compensation		●	●	●	●	●	●	●	
79		Automatic tool offset	G36/G37	●	●	●	●	●	●	●	
80	Direct input of offset value measured B		●	●	●	●	●	●	●		
81	Tool life management		●	●	●	●	●	●	●		
82	Accuracy compensation function	Backlash compensation for each rapid traverse and cutting feed	●	●	●	●	●	●	●	●	
83		Stored pitch error compensation		○	○	○	○	○	○	○	
84	Editing operation	Part program storage size & Number of registerable programs	400 programs_512KB	●	●	●	X	●	X	X	X
85			800 programs_1MB	X	X	X	●	X	●	X	X
86			400 programs_2MB	○	○	○	X	○	X	X	X
87			800 programs_2MB	X	X	X	○	X	○	X	X
88			500 programs_256KB	X	X	X	X	X	X	●	●
89			1000 programs_512KB, 1MB, 2MB, 4MB, 8MB	X	X	X	X	X	X	○	○
90			2000 programs_1MB	X	X	X	X	X	X	○	○
91		4000 programs_2MB, 4MB, 8MB	X	X	X	X	X	X	○	○	
92	Program protect		●	●	●	●	●	●	●	●	
93	Password function		●	●	●	●	●	●	●	●	
94	Playback		●	●	●	●	●	●	○	○	
95	Data input / output	Fast data server		○	○	○	○	○	○	○	○
96		External data input		●	●	●	●	●	●	○	○
97		Memory card input / output		●	●	●	●	●	●	●	●
98		USB memory input / output		●	●	●	●	●	●	●	●
99		Automatic data backup		○	○	○	○	○	○	●	●
100	Interface function	Embedded Ethernet		●	●	●	●	●	●	●	●
101		Fast Ethernet		○	○	○	○	○	○	○	○
102	Others	Display unit	10.4" color LCD	●	●	●	●	●	●	●	●
103		Robot interface	with PMC I / O module	○	○	○	○	○	○	○	○
104		Robot interface	with PROFIBUS-DP	○	○	○	○	○	○	○	○

Product Preview

Basic information

Basic Structure
Cutting
Performance

Detailed
Information

Options
Applications
Capacity Diagram
Specifications

Customer Support
Service

Responding to Customers Anytime, Anywhere



Global Service Support Network

Corporations

5

Dealer Networks

122

Technical Centers

18

Factories

3

Technical Center: Sales Support, Service Support, Parts Support

Doosan Machine Tools' Global Network, Responding to Customer's Needs nearby, Anytime, Anywhere

Doosan machine tools provides a system-based professional support service before and after the machine tool sale by responding quickly and efficiently to customers' demands. By supplying spare parts, product training, field service and technical support, we can provide top class support to our customers around the world.



Customer Support Service

We help customers to achieve success by providing a variety of professional services from pre-sales consultancy to post-sales support.

Supplying Parts



- Supplying a wide range of original Doosan spare parts
- Parts repair service

Field Services



- On site service
- Machine installation and testing
- Scheduled preventive maintenance
- Machine repair

Technical Support



- Supports machining methods and technology
- Responds to technical queries
- Provides technical consultancy

Training



- Programming / machine setup and operation
- Electrical and mechanical maintenance
- Applications engineering

Domestic Service Support Network

Integrated Support Centers

2

Sales Branch Offices

7

Post-Sales Service Centers

6

Designated Repair Service Centers

31

Major Specifications

PUMA 2100 / 2600 / 3100 series



Description	Unit	PUMA 2100	PUMA 2600	PUMA 2600B	PUMA 3100
Max. turning diameter (2axis / M&Y)	mm (inch)	481 / 406 (18.9 / 16.0)	481 / 376 (18.9 / 14.8)	481 / 376 (18.9 / 14.8)	525 / 420 (20.7 / 16.5)
Max. turning length*	mm (inch)	500 / 750 (19.7 / 29.5)	500 / 750 / 1250 (19.7 / 29.5 / 49.2)	750 / 1250 (29.5 / 49.2)	750 / 1250 / 2000 / 3000 (29.5 / 49.2 / 78.7 / 118.1)
Chuck size	inch	8	10	12	12
Bar working diameter	mm (inch)	65 (2.6)	76 (3.0)	102 (4.0)	102 (4.0)
Max. spindle speed	r/min	4500	3500	2800	2800
CNC system	-	DOOSAN FANUC i / FANUC 31i / / SIEMENSE S828D			

* approximate value



Doosan Machine Tools

<http://www.doosanmachinetools.com>

www.facebook.com/doosanmachinetools

Optimal Solutions for the Future

Head Office

Yeonkang Bldg., 6th FL., 270, Yeonji-dong,
Jongno-gu, Seoul, Korea
Tel +82-2-3670-5345 / 5362
Fax +82-2-3670-5382

Doosan Machine Tools America

19A Chapin Rd., Pine Brook, NJ 07058, U.S.A.
Tel +1-973-618-2500
Fax +1-973-618-2501

Doosan Machine Tools China

Room 101,201,301, Building 39 Xinzhuang Highway
No.258 Songjiang District,China Shanghai(201612)
Tel +86 21-5445-1155
Fax +86 21-6405-1472

Doosan Machine Tools Europe

Emdener Strasse 24, D-41540 Dormagen, Germany
Tel +49-2133-5067-100
Fax +49-2133-5067-001

Doosan Machine Tools Japan

#2412, Mita Kokusai Bldg. 1-4-28 Mita,
Minato-ku, Tokyo 108-0073, Japan
Tel +81 3 5730 9013
Fax +81 3 5730 9016

Doosan Machine Tools India

106 / 10-11-12, Amruthahalli, Byatarayanapura,
Bellary road, Bangalore-560 092, India
Tel +91-80-4266-0122 / 121 / 100



* For more details, please contact Doosan Machine Tools.

* The specifications and information above-mentioned may be changed without prior notice.

* Doosan Machine Tools Co., Ltd. is a subsidiary of MBK Partners, a Korean private equity firm. The trademark  DOOSAN is used under a licensing agreement with Doosan Corporation, the registered trademark holder.